

# User's Manual

**DuraVision®**

**FDS1904**

**FDS1904-OP**

**FDU2603W**

**FDU2603W-OP**

**Color LCD Monitor**

**FDS1904T**

**FDS1904T-OP**

**FDU2603WT**

**FDU2603WT-OP**

**Touch Panel Color LCD Monitor**

## **Important**

Please read this User's Manual, and the Setup Manual (separate volume) carefully to familiarize yourself with safe and effective usage.

- 
- Please refer to the Setup Manual for basic information ranging from monitor installation to using the monitor.
  - The latest User's Manual is available for download from our web site:  
<http://www.eizoglobal.com>
- 



---

---

No part of this manual may be reproduced, stored in a retrieval system, or transmitted, in any form or by any means, electronic, mechanical, or otherwise, without the prior written permission of EIZO Corporation. EIZO Corporation is under no obligation to hold any submitted material or information confidential unless prior arrangements are made pursuant to EIZO Corporation's receipt of said information. Although every effort has been made to ensure that this manual provides up-to-date information, please note that EIZO monitor specifications are subject to change without notice.

---

---

# Notice for this monitor

---

This product may not be covered by warranty for uses other than those described in the Setup Manual.

---

The specifications noted in this manual are only applicable when the following are used:

- Signal cables specified by us
- 

Only use optional products manufactured or specified by us with this product.

---

It takes about 30 minutes for the performance of electrical parts to stabilize. Please wait 30 minutes or more after the monitor power has been turned on, and then adjust the monitor.

---

Monitors should be set to a lower brilliance to reduce changes in luminosity caused by long-term use and maintain a stable display.

---

When the screen image is changed after displaying the same image for extended periods of time, an afterimage may appear. Use the screen saver or power save function to avoid displaying the same image for extended periods of time.

---

Periodic cleaning is recommended to keep the monitor looking new and to prolong its operation lifetime (refer to [“Cleaning” \(page 4\)](#)).

---

The LCD panel is manufactured using high-precision technology. Although, missing pixels or lit pixels may appear on the LCD panel, this is not a malfunction. Percentage of effective dots: 99.9994% or higher.

---

The backlight of the LCD panel has a fixed lifetime. When the screen becomes dark or begins to flicker, please contact your local EIZO representative.

---

Do not scratch or press on the panel with any sharp objects, as this may result in damage to the panel. Do not attempt to brush with tissues as this may scratch the panel.

---

When the monitor is cold and brought into a room or the room temperature goes up quickly, dew condensation may occur on the interior and exterior surfaces of the monitor. In that case, do not turn the monitor on. Instead wait until the dew condensation disappears, otherwise it may cause some damage to the monitor.

---

(Cautions for the Use of the Touch Panel)

- During touch operation
    - Be careful of the following points. Otherwise, damage may occur to the monitor.
    - Do not strongly press, scratch, or poke the panel.
    - Do not touch the panel with hard objects such as ballpoint pens or metals.
-

# Cleaning

---

## **Attention**

- Chemicals such as alcohol and antiseptic solution may cause gloss variation, tarnishing, and fading of the panel, and also quality deterioration of the image.
  - Never use any thinner, benzene, wax, and abrasive cleaner, which may damage the panel.
  - Do not allow liquid to enter the clearance between the panel and the panel frame.
- 

The stains on the panel surface can be removed by using the provided cleaning cloth.

# To use the monitor comfortably

---

- An excessively dark or bright screen may affect your eyes. Adjust the brightness of the monitor according to the environmental conditions.
- Staring at the monitor for a long time tires your eyes. Take a 10-minute rest every hour.

# CONTENTS

<b>Notice for this monitor</b> .....	<b>3</b>	<b>Chapter 4 Touch Panel Settings</b>	
Cleaning .....	4	<b>(FDS1904T / FDU2603WT)</b> .....	<b>24</b>
To use the monitor comfortably .....	4	4-1. Calibrating the Monitor .....	24
<b>CONTENTS</b> .....	<b>5</b>	4-2. Configuring Touch Panel Operation	
<b>Chapter 1 Introduction</b> .....	<b>6</b>	Settings .....	26
1-1. Features .....	6	4-3. Setting Touch Sound .....	27
1-2. EIZO LCD Utility Disk .....	7	<b>Chapter 5 Power Saving Functions</b> .....	<b>28</b>
● Disk contents and software overview .....	7	5-1. Setting Power Saving .....	28
1-3. Basic Operations and Functions .....	8	5-2. Setting the automatic power off function...	28
● Basic Adjustment menu operations .....	8	<b>Chapter 6 Troubleshooting</b> .....	<b>29</b>
● Showing button guide .....	9	6-1. No picture .....	29
● Functions .....	10	6-2. Imaging problems (for both digital and	
<b>Chapter 2 Adjusting Screens</b> .....	<b>11</b>	analog) .....	30
2-1. Setting the Resolution .....	11	6-3. Imaging problems (for analog only) .....	31
● Display resolution .....	11	6-4. Other problems .....	31
● Setting resolution .....	11	6-5. Touch panel problems (for FDS1904T /	
2-2. Displaying Screen Correctly .....	12	FDU2603WT only) .....	32
● Digital Signal Input .....	12	<b>Chapter 7 Reference</b> .....	<b>33</b>
● Analog Signal Input .....	12	7-1. Connecting Multiple PCs .....	33
2-3. Adjusting Color .....	15	● To switch among input signals .....	34
● Adjusting brilliance (brightness) .....	15	● To set input signal selection .....	34
● To adjust color temperature .....	16	7-2. Displaying monitor information .....	35
● To adjust gamma .....	16	● Displaying signal information .....	35
● To adjust hue .....	16	● Displaying monitor information .....	35
● To adjust color saturation .....	17	7-3. How to Replace the Cooling Fan .....	36
● To enhance outline of image .....	17	7-4. Specifications .....	40
● To adjust gain .....	17	● FDS1904 / FDS1904-OP .....	40
2-4. Selecting Screen Size .....	18	● FDS1904T / FDS1904T-OP .....	41
2-5. Enabling / Disabling Auto Sharpness .....	18	● FDU2603W / FDU2603W-OP .....	43
<b>Chapter 3 Setting Monitor</b> .....	<b>19</b>	● FDU2603WT / FDU2603WT-OP .....	44
3-1. Setting Brightness of Front Button .....	19	● Pin Assignment .....	47
3-2. Setting Language .....	19	7-5. Preset Timing .....	49
3-3. Changing Adjustment Menu Display		<b>Chapter 8 Glossary</b> .....	<b>50</b>
Position .....	19	<b>Appendix</b> .....	<b>52</b>
3-4. Setting the Adjustment Menu orientation ...	20	Trademark .....	52
3-5. Enabling / Disabling DDC/CI		License / Copyright .....	52
communication .....	20	Testing Standard .....	53
3-6. Locking Buttons .....	21	Type approval of ship classification .....	53
3-7. Setting Backlight Off Mode .....	21	CE .....	53
3-8. Turning the ECDIS Indicator ON / OFF .....	22	LIMITED WARRANTY .....	54
3-9. Return To Default Setting .....	23	Recycling Information .....	64
● To reset the color adjustment value .....	23		
● To reset all adjustments to the default			
settings .....	23		
● Resetting Brightness (Brilliance) .....	23		

# Chapter 1 Introduction

Thank you very much for choosing an EIZO color LCD monitor.

## 1-1. Features

- 19.0" LCD (FDS1904 / FDS1904T)
- 25.5" LCD (FDU2603W / FDU2603WT)  
Provides a display area (vertical: over 340 mm) required for radar on large ships.
- Applicable to the resolution of 1280 × 1024. (FDS1904 / FDS1904T)
- Applicable to the resolution of 1920 × 1200. (FDU2603W / FDU2603WT)
- Panel with a wide field of view adopted
  - Horizontal : 178°, vertical : 178°(FDS1904 / FDS1904T)
  - Horizontal : 176°, vertical : 176°(FDU2603W / FDU2603WT)
- Dimming down to the low brightness  
The mode allows the user to turn off the backlight.  
(You can set the brightness when "Brilliance" in the Adjustment menu is set to the lower limit value.)  
See "3-7. Setting Backlight Off Mode" (page 21).
- The buttons on the front of the monitor light up.  
The buttons on the front of the monitor (operation buttons) light up orange to enable the monitor to be operated in a dark environment as well. Their brightness can also be adjusted.  
See "3-1. Setting Brightness of Front Button" (page 19).
- Cooling fan replacement is possible.  
See "7-3. How to Replace the Cooling Fan" (page 36).
- Built-in warning buzzer  
Controlled on the system side.
- Equipped with AC/DC power supplies.  
Both AC power input and DC power input are provided to enable installation in various environments. In addition, connecting both power inputs can provide a helpful backup if the AC power supply fails. (The AC power supply takes priority during operation when both power inputs are connected.)
- HDCP (High-bandwidth Digital Content Interface)
- Type approval of ship classification  
This product is pending approval for the following types of ship classifications.
  - NK (Nippon Kaiji Kyokai)
  - DNV (Det Norske Veritas)
  - ABS (American Bureau of Shipping)
  - LR (Lloyd's Register of Shipping)For the latest information on approvals for ship classifications, please refer to our website.  
<http://www.eizoglobal.com>
- Testing Standards  
This product complies with the IEC60945 4th edition standard.
- Optical bonding for increased screen strength and visibility\*<sup>1</sup>  
(option: FDS1904-OP / FDS1904T-OP, FDU2603W-OP / FDU2603WT-OP)  
<sup>\*1</sup> A technique in which a layer of resin is used to fill the gap (layer of air) between the LCD panel and clear panel / touch panel, adhering the two together.

### (FDS1904T / FDU2603WT only)

- Touch Panel provided
  - Projected capacitive technology
  - Supports the Windows Touch function (multi-touch) of Windows 8.1 / Windows 8 / Windows 7.

## 1-2. EIZO LCD Utility Disk

An “EIZO LCD Utility Disk” (CD-ROM) is supplied with this product. The following table shows the disk contents and the overview of the software programs.

### ● Disk contents and software overview

The disk includes adjustment software, touch panel software, and user’s manuals. Refer to Readme.txt file on the disk for software startup procedures or file access procedures.

Item	Overview
Screen adjustment pattern files	Used when adjusting the image of analog signal input manually.
Touch Panel Driver* <sup>1</sup>	Driver software for the touch panel.* <sup>2</sup>  * If the following conditions are satisfied, use the standard Windows driver. <ul style="list-style-type: none"><li>• The PC and monitor are connected with a USB cable</li><li>• The OS is Windows 8.1, Windows 8 or Windows 7</li></ul> For setup details please refer to “ <a href="#">Chapter 4 Touch Panel Settings (FDS1904T / FDU2603WT)</a> ” (page 24).
TPOffset* <sup>1</sup>	Software for adjusting the sensitivity of the touch panel* <sup>2</sup> Use this software when touch operations are not registered or only registered after pressing hard.
User’s Manual of this monitor (PDF file)	
Readme.txt file	

\*<sup>1</sup> Used only for the FDS1904T / FDU2603WT.

\*<sup>2</sup> Refer to the corresponding User’s Manual on the CD-ROM for details on installation and use.

# 1-3. Basic Operations and Functions

## ● Basic Adjustment menu operations

**Note**

- The language is set to English in the default settings. To change the language, please refer to “3-2. Setting Language” (page 19).

### 1. Displaying Adjustment Menu

1. Press **○**. The Adjustment menu appears.

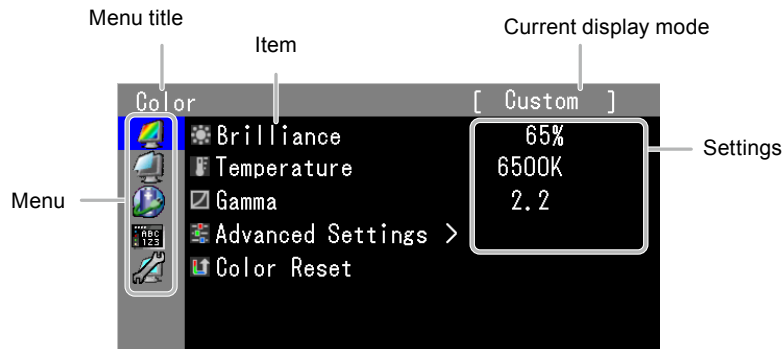

### 2. Adjusting / Setting

1. Choose a menu to adjust / set with **◀ ▶**, and then press **○**.

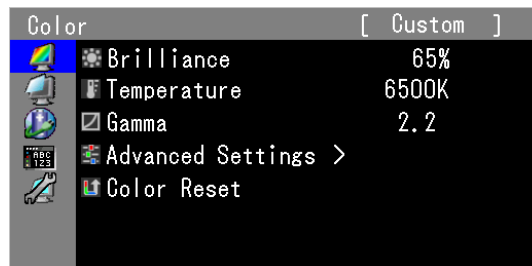

2. Choose an item to adjust / set with **◀ ▶**, and then press **○**.

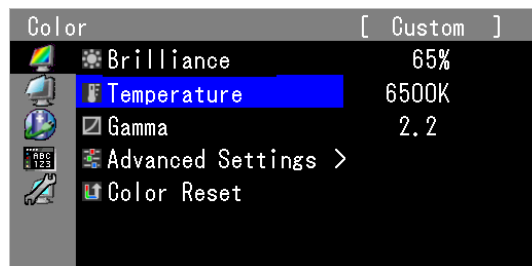

3. Adjust / set the selected item with **◀ ▶**, and then press **○**.

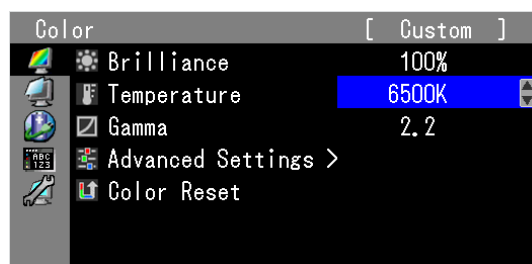



### 3. Exiting

1. Press  a few times. The Adjustment menu finishes.

### ● Showing button guide

Press the front buttons other than , and the button guide appears above the button.

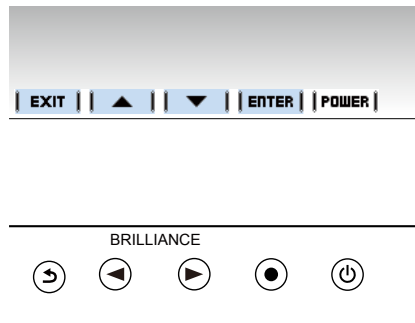

































---

#### Note

- The Button Guide will continue to appear while the Adjustment menu is showing.
  - The Button Guide is displayed differently depending on the selected menu or status.
-

## ● Functions

The following table shows all the Adjustment menu's adjustment and setting menus.

Main menu	Setting	Reference
Color <sup>*1</sup> 	 Brilliance	<a href="#">"2-3. Adjusting Color" (page 15)</a>
	 Temperature <sup>*2</sup>	
	 Gamma <sup>*2</sup>	
	 Advanced Settings  Hue <sup>*2</sup>	
	 Saturation <sup>*2</sup>	
	 Outline Enhancer  Gain <sup>*2</sup>	<a href="#">"3-9. Return To Default Setting" (page 23)</a>
 Color Reset		
Screen 	 Screen Size	<a href="#">"2-4. Selecting Screen Size" (page 18)</a>
	 Analog Adjustment  Auto Adjustment	<a href="#">"2-2. Displaying Screen Correctly" (page 12)</a>
	 Range Adjustment	
	 Clock	
	 Phase	
	 Hor. Position	
	 Ver. Position	
Power Manager 	 Power Save	<a href="#">"5-1. Setting Power Saving" (page 28)</a>
	 Indicator	<a href="#">"3-1. Setting Brightness of Front Button" (page 19)</a>
	 Eco Timer	<a href="#">"5-2. Setting the automatic power off function" (page 28)</a>
Menu Settings 	 Language	<a href="#">"3-2. Setting Language" (page 19)</a>
	 Menu Position	<a href="#">"3-3. Changing Adjustment Menu Display Position" (page 19)</a>
Tools 	 Input	<a href="#">"To switch among input signals" (page 34)</a>
	 Input Selection	<a href="#">"To set input signal selection" (page 34)</a>
	 Auto Sharpness	<a href="#">"2-5. Enabling / Disabling Auto Sharpness" (page 18)</a>
	 Signal Info	<a href="#">"7-2. Displaying monitor information" (page 35)</a>
	 Monitor Info	
	 All Reset	<a href="#">"3-9. Return To Default Setting" (page 23)</a>

\*1 Depending on which display mode has been applied to the product, the adjustable items under "Color" may vary.

\*2 Adjustments are not possible in the three ECDIS Standard compatible modes (Day, Dusk, Night).

### Attention

- Display Mode has three ECDIS Standard compatible modes (Day, Dusk, Night) and a mode where you can make settings of your choice (Custom). However, the Display Mode cannot be changed using the monitor. Changes can be made on the system side.

# Chapter 2 Adjusting Screens

## 2-1. Setting the Resolution

### ● Display resolution

For details on compatible resolutions, refer to “Compatible Resolutions” in the Setup Manual.

### ● Setting resolution

When you connect the monitor to the PC and find that the resolution is improper, or when you want to change the resolution, follow the procedure below.

#### Windows 8.1 / Windows 8 / Windows 7

1. For Windows 8.1 / Windows 8, click the “Desktop” tile on the Start Screen to display the desktop.
2. Right-click the mouse anywhere on the desktop except for icons.
3. From the displayed menu, click “Screen resolution”.
4. On the “Screen Resolution” dialog box, select the monitor.
5. Click “Resolution” to select the desired resolution.
6. Click the “OK” button.
7. When a confirmation dialog box is displayed, click “Keep changes”.

#### Windows Vista

1. Right-click the mouse anywhere on the desktop except for icons.
2. From the displayed menu, click “Personalize”.
3. On the “Personalization” window, click “Display Settings”.
4. On the “Display Settings” dialog box, select the “Monitor” tab and select desired resolution in the “Resolution” field.
5. Click the “OK” button.
6. When a confirmation dialog box is displayed, click “Yes”.

#### Windows XP

1. Right-click the mouse anywhere on the desktop except for icons.
2. From the displayed menu, click “Properties”.
3. When the “Display Properties” dialog box is displayed, click the “Settings” tab and select desired resolution for “Screen resolution” under “Display”.
4. Click the “OK” button to close the dialog box.

#### Mac OS X

1. Select “System Preferences” from the Apple menu.
2. When the “System Preferences” dialog box is displayed, click “Displays” for “Hardware”.
3. On the displayed dialog box, select the “Display” tab and select desired resolution in the “Resolutions” field.
4. Your selection will be reflected immediately. When you are satisfied with the selected resolution, close the window.

## 2-2. Displaying Screen Correctly

---

### ● Digital Signal Input

When digital signals are input, images are displayed correctly based on the preset data of the monitor. When performing advanced adjustment, see “2-3. Adjusting Color” (page 15) and subsequent pages.

### ● Analog Signal Input

---

**Attention**

- It takes about 30 minutes for the performance of electrical parts to stabilize. Please wait 30 minutes or more after the monitor power has been turned on, and then adjust the monitor.
- The self adjustment function does not work for the images under the vertical resolution of 480 or less.
- The self adjustment and auto adjustment functions work correctly when an image is fully displayed over the Windows or Macintosh display area. They do not work properly in the cases below:
  - When an image is displayed only on a part of the screen (command prompt window, for example)
  - When a black background (wallpaper, etc.) is in use

Also, these functions cannot work properly in some graphic boards.

---

The monitor screen adjustment is used to suppress flickering of the screen or adjust screen position and screen size correctly according to the PC to be used.

---

**Note**

- The self adjustment function works when all of the following conditions are satisfied:
    - When a signal is input into the monitor for the first time or when a resolution or vertical / horizontal scan frequency not used before is set
- 

If the screen is not displayed correctly even after performing the self adjustment operation, adjust the screen according to the procedures on the following pages to use the monitor comfortably.

## Setting Procedures

### 1. Prepare to use analog screen adjustment patterns.

Load the “EIZO LCD Utility Disk” to your PC, and then open the “Screen adjustment pattern files”.

---

**Note**

- For details and instructions on opening the “Screen adjustment pattern files”, refer to the Readme.txt file.
- 

### 2. Perform the auto adjustment with the analog screen adjustment pattern displayed.

#### ● To adjust flickering, screen position, and screen size automatically

##### **Procedure**

1. Display Pattern 1 in full screen on the monitor using the “Screen adjustment pattern files”.

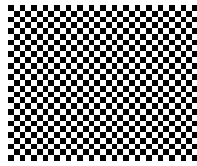

2. Choose “Screen” from the Adjustment menu, and press .
3. Choose “Analog Adjustment” from the “Screen” menu, and press .
4. Choose “Auto Adjustment”, and press .

The auto adjustment function works (the message “In Progress” appears) to adjust the flickering, screen position, and screen size correctly.

When the auto adjustment is completed, a message appears. Select “OK” to confirm the new settings or “Cancel” to restore the previous settings, and press .







If the screen is not displayed correctly even after performing auto adjustment, perform the adjustments according to the procedures on the following pages. If the screen is displayed correctly, go to [“4. Adjusting color gradation.”](#) (page 15).

### 3. Perform advanced adjustments for the following using “Analog Adjustment” of “Screen”.

Adjust the clock, phase and position, in this order.

#### ● To eliminate vertical bars

##### Procedure



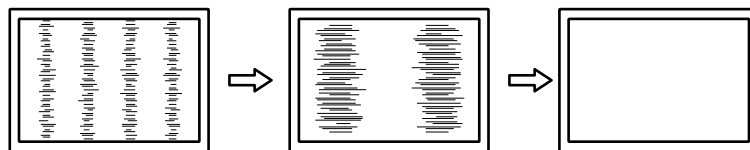

1. Choose “Clock” from the “Analog Adjustment” menu, and press .
2. Adjust the clock with  or  to eliminate vertical bars.  
Press  or  slowly so as not to miss the adjustment point.
3. Press  to exit the adjustment.

When blurring, flickering or bars appear on the screen after adjustment, proceed to “To remove flickering or blurring” to remove flickering or blurring.



#### ● To remove flickering or blurring

##### Procedure

1. Choose “Phase” from the “Analog Adjustment” menu, and press .
2. Adjust the phase with  or  to minimize flickering or blurring.
3. Press  to exit the adjustment.

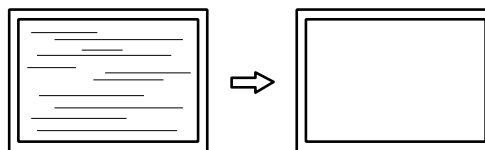

---

##### **Attention**

- Flickering or blurring may not be eliminated depending on your PC or graphics board.
- 





#### ● To correct the screen position

---

##### **Note**

- Since the number of pixels and the pixel positions are fixed on the LCD monitor, only one position is provided to display images correctly. The position adjustment is made to shift an image to the correct position.
- 

##### Procedure

1. Choose “Hor.Position” or “Ver.Position” from the “Analog Adjustment” menu, and press .
2. Adjust the position with  or .
3. Press  to exit the adjustment.

When vertical bars appear on the screen after adjustment, go back to “To eliminate vertical bars”. (Clock → Phase → Position)

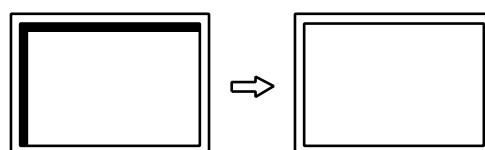

4. Close Pattern 1.

## 4. Adjusting color gradation.

### ● To adjust color gradation automatically

Every color gradation (0 to 255) can be displayed by adjusting the signal output level.

#### **Procedure**

1. Display Pattern 2 in full screen on the monitor using the “Screen adjustment pattern files”.

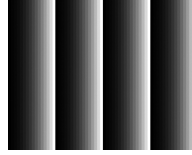

2. Choose “Screen” from the Adjustment menu, and press **⏏**.
3. Choose “Analog Adjustment” from the “Screen” menu, and press **⏏**.
4. Choose “Range Adjustment” from the “Analog Adjustment” menu, and press **⏏**.

The color gradation is adjusted automatically.

When the auto adjustment is completed, a message appears. Select “OK” to confirm the new settings or “Cancel” to restore the previous settings, and press **⏏**.

5. Close Pattern 2.

## 2-3. Adjusting Color

#### **Attention**

- It takes about 30 minutes for the performance of electrical parts to stabilize. Please wait 30 minutes or more after the monitor power has been turned on, and then adjust the monitor.
- The same image may be seen in different colors on multiple monitors due to their monitor-specific characteristics. Make fine color adjustment visually when matching colors on multiple monitors.

#### **Note**

- The values shown in “%” or “K” are available only as reference.

### ● Adjusting brilliance (brightness)

The screen brightness is adjusted by changing the brightness of the backlight (light source from the LCD back panel).

#### **Adjustable range**

1 to 100%	when “Backlight Off Mode” is set to “Off” ( <a href="#">page 21</a> )
0 to 100%	when “Backlight Off Mode” is set to “On” ( <a href="#">page 21</a> ) (When the lower limit value (0%) is set, the backlight is turned off to darken the screen.)

#### **Procedure**

1. Choose “Color” from the Adjustment menu, and press **⏏**.
2. Choose “brilliance” from “Color”, and press **⏏**.
3. Use **⏏** or **⏏** for adjustment.
4. Press **⏏** to exit.

#### **Note**

- The brightness can be set by directly pressing **⏏** or **⏏** (For the setting value, please display and check “Color”.)
- When adjusting brilliance by long pressing **⏏** or **⏏**, adjustment terminates when the default setting is reached. You can continue adjustment by pressing **⏏** or **⏏** again (When “ECDIS indicator” is “ON”, and the monitor Display Mode is set to “Day”, “Dusk”, “Night”).

## ● To adjust color temperature

The color temperature can be adjusted.

The color temperature is normally used to express the hue of “White” and/or “Black” by a numerical value. The value is expressed in degrees “K” (Kelvin).

The screen becomes reddish at a low color temperature, and bluish at a high color temperature, like the flame temperature. The gain preset values are set for each color temperature setting value.

### **Adjustable range**

Native, 4000K-10000K (specified by every 500K unit, including 9300K)

### **Procedure**

1. Choose “Color” from the Adjustment menu, and press **⊙**.
2. Choose “Temperature” from “Color”, and press **⊙**.
3. Use **◀** or **▶** for adjustment.
4. Press **⊙** to exit.

---

#### **Note**

- “Gain” allows you to perform more advanced adjustment (see [“To adjust gain” \(page 17\)](#)).
  - If you set “Native”, the image is displayed in the preset color of the monitor (Gain: 100% for each RGB).
  - When gain is changed, the color temperature is changed to “User”.
- 

## ● To adjust gamma

Gamma can be adjusted. The brightness of the monitor varies depending on the input signal, however, the variation rate is not proportional to the input signal. To keep the balance between the input signal and the brightness of the monitor is called as “Gamma correction”.

### **Adjustable range**

1.8, 2.0, 2.2, 2.4, 2.6

### **Procedure**

1. Choose “Color” from the Adjustment menu, and press **⊙**.
2. Choose “Gamma” from “Color”, and press **⊙**.
3. Use **◀** or **▶** for adjustment.
4. Press **⊙** to exit.

## ● To adjust hue

This function allows you to adjust the hue.

### **Adjustable range**

-100 to 100

### **Procedure**

1. Choose “Color” from the Adjustment menu, and press **⊙**.
2. Choose “Advanced Settings” from “Color”, and press **⊙**.
3. Choose “Hue”, and press **⊙**.
4. Use **◀** or **▶** for adjustment.
5. Press **⊙** to exit.

---

#### **Attention**

- Using this function may make some color gradations unavailable for display.
-



## ● To adjust color saturation

This function allows you to adjust color saturation.

### **Adjustable range**

-100 to 100

### **Procedure**

1. Choose “Color” from the Adjustment menu, and press **⊙**.
2. Choose “Advanced Settings” from “Color”, and press **⊙**.
3. Choose “Saturation”, and press **⊙**.
4. Use **◀** or **▶** for adjustment.
5. Press **⊙** to exit.

---

### **Attention**

- Using this function may make some color gradations unavailable for display.

---

### **Note**

- The minimum value (-100) changes the screen to monochrome.
- 

## ● To enhance outline of image

Outline Enhancer functions to emphasize outline of the images by emphasizing the color difference between pixels composing the images. This may improve the texture of the material and its feel of the images. On the contrary, it also functions to reproduce the images smoothly by gradating its outline.

### **Procedure**

1. Choose “Color” from the Adjustment menu, and press **⊙**.
2. Choose “Advanced Settings” from “Color”, and press **⊙**.
3. Choose “Outline Enhancer”, and press **⊙**.
4. Select the display status in the range from -3 to 3 (soft to sharp) with **◀** or **▶** as desired.
5. Press **⊙** to exit.

## ● To adjust gain

The brightness of each color component red, green, and blue is called “Gain”. You can change the hue of “white” by adjusting gain.

### **Adjustable range**

0 to 100%

### **Procedure**

1. Choose “Color” from the Adjustment menu, and press **⊙**.
2. Choose “Advanced Settings” from “Color”, and press **⊙**.
3. Choose “Gain”, and press **⊙**.
4. Choose the color to adjust from “Red”, “Green”, and “Blue”, and then press **⊙**.
5. Use **◀** or **▶** for adjustment.
6. Press **⊙** to exit.

---

### **Attention**

- Using this function may make some color gradations unavailable for display.

---

### **Note**

- The value of gain changes with that of color temperature.
  - When gain is changed, the color temperature is changed to “User”.
-

## 2-4. Selecting Screen Size

The image with the resolution other than the recommended resolution is displayed in full screen automatically. You can change the screen size by using the “Screen Size” function from “Screen”.

Setting	Function
Full	Displays an image in full screen. Images are distorted in some cases because the vertical rate is not equal to the horizontal rate.
Enlarged	Displays an image in full screen. In some cases, a blank horizontal or vertical border appears to equalize the vertical rate and the horizontal rate.
Normal	Displays images with the specified resolution.

Example: Image size 1024 × 768

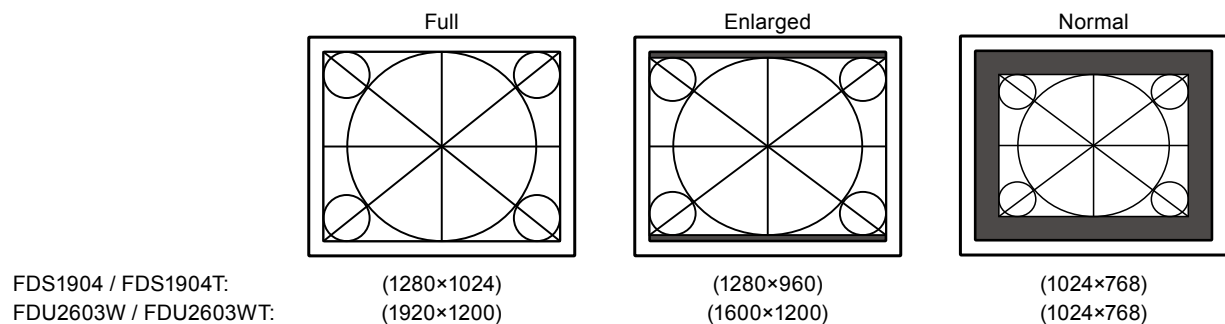

### Procedure

1. Choose “Screen” from the Adjustment menu, and press **⊙**.
2. Choose “Screen Size” from “Screen”, and press **⊙**.
3. Select “Full”, “Enlarged”, or “Normal” with **⏪** or **⏩**.
4. Press **⊙** to exit.

### Attention

- Selecting “Normal” may make some color gradations unavailable for display.

## 2-5. Enabling / Disabling Auto Sharpness

By enabling Auto Sharpness outlines will be adjusted according to the displayed image which can improve its feel and texture.

### Procedure

1. Choose “Tools” from the Adjustment menu, and press **⊙**.
2. Choose “Auto Sharpness” from “Tools”, and press **⊙**.
3. Select “On” or “Off” with **⏪** or **⏩**.
4. Press **⊙** to exit.

### Note

- The extent of adjustment depends on the setting value of “Outline Enhancer”.

# Chapter 3 Setting Monitor

## 3-1. Setting Brightness of Front Button

The brightness of the front buttons (control button and power button) can be set.

### Attention

- They are set to light up under the following condition, and are set to “4” by default.
  - Power button: When the power cord is connected to the power outlet.
  - Control button: When the power button is turned on.

### Procedure

1. Choose “PowerManager” from the Adjustment menu, and press **⊙**.
2. Choose “Indicator” from “PowerManager”, and press **⊙**.
3. Set the brightness so it is in the range from 1 to 7 with **◀** or **▶** as desired.
4. Press **⊙** to exit.

## 3-2. Setting Language

This function allows you to select a language for the Adjustment menu and messages.

### Selectable languages

English, German, French, Spanish, Italian, Swedish, Japanese, Simplified Chinese, Traditional Chinese

### Procedure

1. Choose “Menu Settings” from the Adjustment menu, and press **⊙**.
2. Choose “Language” from “Menu Settings”, and press **⊙**.
3. Select a language with **◀** or **▶**.
4. Press **⊙** to exit.

## 3-3. Changing Adjustment Menu Display Position

You can change the display position of the Adjustment menu.

### Procedure

1. Choose “Menu Settings” from the Adjustment menu, and press **⊙**.
2. Choose “Menu Position” from “Menu Settings”, and press **⊙**.
3. Choose the position with **◀** or **▶**.
4. Press **⊙** to exit.

## 3-4. Setting the Adjustment Menu orientation

When the monitor is set to the portrait display mode, the orientation of the Adjustment Menu can be changed as well.

Default setting: Landscape

### **Procedure**

1. Press  $\odot$  for five seconds or more to turn off the monitor.
2. Holding  $\ominus$  down, press  $\odot$  for at least two seconds to turn on the monitor.  
The "Optional Settings" menu appears.
3. Choose "Orientation" from "Optional Settings", and press  $\odot$ .
4. Select "Landscape" or "Portrait" with  $\blacktriangleleft$  or  $\blacktriangleright$ , and press  $\odot$ .
5. Select "Finish" with  $\blacktriangleleft$  or  $\blacktriangleright$ .
6. Press  $\odot$ .

The "Optional Settings" menu is closed.

---

### **Note**

- When using the monitor screen in a portrait position, the graphics board supporting portrait display is required. When placing the monitor in a portrait position, the settings of your graphics board need to be changed. Refer to the User's Manual of the graphics board for details.
- 

## 3-5. Enabling / Disabling DDC/CI communication

This function allows you to enable / disable the DDC/CI communication (see "[Chapter 8 Glossary](#)" (page 50)).

### **Procedure**

1. Press  $\odot$  for five seconds or more to turn off the monitor.
2. Holding  $\ominus$  down, press  $\odot$  for at least two seconds to turn on the monitor.  
The "Optional Settings" menu appears.
3. Choose "DDC/CI" from "Optional Settings", and press  $\odot$ .
4. Select "On" or "Off" with  $\blacktriangleleft$  or  $\blacktriangleright$ , and press  $\odot$ .
5. Select "Finish" with  $\blacktriangleleft$  or  $\blacktriangleright$ .
6. Press  $\odot$ .

The "Optional Settings" menu is closed.

## 3-6. Locking Buttons

This function allows you to lock the adjusted / set status to prevent changing them.

### Procedure

1. Press  $\odot$  for five seconds or more to turn off the monitor.
2. Holding  $\ominus$  down, press  $\odot$  for at least two seconds to turn on the monitor.  
The “Optional Settings” menu appears.
3. Choose “Key Lock” from “Optional Settings”, and press  $\odot$ .
4. Choose “Off”, “Menu”, or “All” with  $\leftarrow$  or  $\rightarrow$ , and press  $\odot$ .

Settings	Buttons that can be locked
Off (Default setting)	None (All buttons are enabled)
Menu	$\odot$ button
All	All buttons excluding $\odot$

5. Select “Finish” with  $\leftarrow$  or  $\rightarrow$ .
6. Press  $\odot$ .  
The “Optional Settings” menu is closed.

### Note

- If buttons are pressed while locked, “Locked” is displayed on the screen.

## 3-7. Setting Backlight Off Mode

This function allows you to set the condition when “Brilliance” is set to the lower limit value.





Setting	Function
On	When “Brilliance” is set to the lower limit value, the backlight is turned off to darken the screen. (However, this excludes when the Adjustment menu, “Signal Error”, or the EIZO logo are displayed)
Off	Even when “Brilliance” is set to the lower limit value, the screen is not darkened.

### Procedure

1. Press  $\odot$  for five seconds or more to turn off the monitor.
2. Holding  $\ominus$  down, press  $\odot$  for at least two seconds to turn on the monitor.  
The “Optional Settings” menu appears.
3. Choose “Backlight Off Mode” from “Optional Settings”, and press  $\odot$ .
4. Select “On” or “Off” with  $\leftarrow$  or  $\rightarrow$ , and press  $\odot$ .
5. Select “Finish” with  $\leftarrow$  or  $\rightarrow$ .
6. Press  $\odot$ .  
The “Optional Settings” menu is closed.

## 3-8. Turning the ECDIS Indicator ON / OFF











The ECDIS Indicator will light up when this setting is set to ON. Please use this as a guide to adjust the monitor brightness.

ECDIS Indicator	Monitor status
	The monitor brilliance is set to the ECDIS adjustment value.
	The monitor brilliance is set higher than the ECDIS adjustment value.
	The monitor brilliance is set lower than the ECDIS adjustment value.
	The ECDIS Indicator does not light up in the following cases. <ul style="list-style-type: none"><li>• The "ECDIS Indicator" is "OFF"</li><li>• It deviates significantly from the ECDIS adjustment value</li><li>• The correct code has not been entered</li></ul>

### Attention

- The ECDIS Indicator becomes active when the monitor display mode is set to "Day", "Dusk" or "Night".
- The Display Mode cannot be changed using the monitor. Changes can be made on the system side.

### Procedure

1. Press  for five seconds or more to turn off the monitor.
  2. Holding  down, press  for at least two seconds to turn on the monitor.  
The "Optional Settings" menu appears.
  3. Choose "ECDIS Indicator" from "Optional Settings", and press .
  4. Select "On" or "Off" with  or , and press .
  5. Select "Finish" with  or .
  6. Press .
- The "Optional Settings" menu is closed.

## 3-9. Return To Default Setting

---

There are two different Resets: Color Reset for only resetting the color adjustments to the default settings and All Reset for resetting all settings to the defaults. There is also a function to reset the screen brightness to the default value.

---

**Attention**

- After resetting, you cannot undo the operation.

---





**Note**

- Regarding the default setting, see [“Main Default Settings” \(page 45\)](#).
- 

### ● To reset the color adjustment value

This function only resets the color adjustment value for the currently selected mode to the default settings.

**Procedure**





1. Choose “Color” from the Adjustment menu, and press .
2. Choose “Color Reset” from “Color”, and press .
3. Choose “Execute” with  or .
4. Press .

The color adjustments revert to the default settings.

### ● To reset all adjustments to the default settings

This function resets all adjustments to the default settings (except the “Input” and “Optional Settings” menu).

**Procedure**

1. Choose “Tools” from the Adjustment menu, and press .
2. Choose “All Reset” from “Tools”, and press .
3. Select “Execute” with  or .
4. Press .

All settings excluding the “Input” and “Optional Settings” menu are reset to the default settings.

### ● Resetting Brightness (Brilliance)

Reset the setting value for the screen brightness (brilliance) to the default setting.

---

**Attention**

- Settings cannot be recovered once this function is executed.
- 

**Procedure**

1. Press  while holding down  or  on the front of the monitor.

The setting value for the screen brightness (brilliance) is reset to the default setting.

# Chapter 4 Touch Panel Settings (FDS1904T / FDU2603WT)

This chapter explains the settings for when the FDS1904T / FDU2603WT is used in an environment that satisfies the following conditions.

- The PC and monitor are connected with a USB cable
- The OS is Windows 8.1 / Windows 8 / Windows 7

---

**Attention**

- If using the FDS1904T / FDU2603WT in either of the following environments, see the Touch Panel Driver User's Manual (on the CD-ROM).
    - The PC and monitor are connected with a USB cable, and the OS being used is Windows XP
    - The PC and monitor are connected with a RS-232C cable
- 

## 4-1. Calibrating the Monitor

---

**Attention**

- Do not put your hands or any metal close to the screen because the screen is susceptible to the dielectric object.
  - If a "User Account Control" dialog box is displayed during operation, proceed according to the displayed instructions.
- 

### 1. Open the Windows Control Panel.

The method for opening the Control Panel differs depending on the OS.

**Windows 8.1**

1. Click  at the bottom of the "Start" screen.  
The "Apps" screen appears.
2. Click "Control Panel" under "Windows System".

**Windows 8**

1. Right-click the mouse on the "Start" screen at a position where there are no tiles.  
App commands appear at the bottom of the screen.
2. Click "All apps".
3. Click "Control Panel" under "Windows System".

**Windows 7**

1. Click "Start" - "Control Panel".



## 2. Click “Hardware and Sound” - “Tablet PC Settings”.

“Tablet PC Settings” window appears.

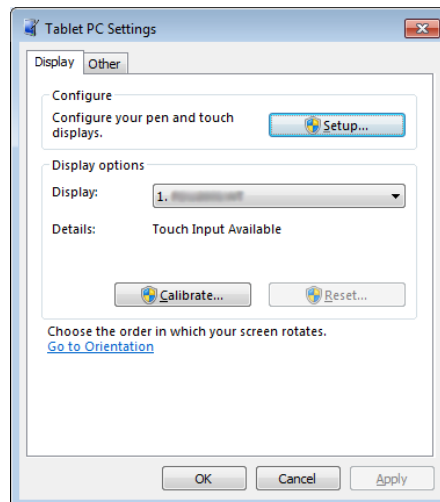

## 3. Click “Setup” in the “Display” tab.

A touchscreen specification screen with a white background is displayed.

### Attention

- If using the monitor in a multiple monitor environment, specify the touchscreen according to the message displayed on screen.

## 4. Touch the screen with your finger.

The touched screen is recognized as a touchscreen.

## 5. Press “Enter” on the keyboard.

The “Tablet PC Settings” window reappears.

## 6. Click “Calibrate”.

A calibration screen with a white background is displayed.

### Attention

- If using the monitor in a multiple monitor environment, select the monitor for calibration from the “Display” pulldown menu and then click “Calibrate”.

## 7. Touch the calibration target (cross) for a few seconds with your finger and release.

The calibration target appears on the screen 16 times, starting from the top left to top right and then down to the bottom left to bottom right.

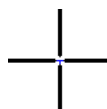

### Note

- For second or subsequent calibrations, the calibration target appears 4 times.

## 8. After completing calibration, click “Yes” to save the calibration data.

## 9. Click “OK” to close the window.

## 4-2. Configuring Touch Panel Operation Settings

### 1. Open the Windows Control Panel.

The method for opening the Control Panel differs depending on the OS (see [page 24](#)).

### 2. Click “Hardware and Sound” - “Pen and Touch”.

“Pen and Touch” window appears.

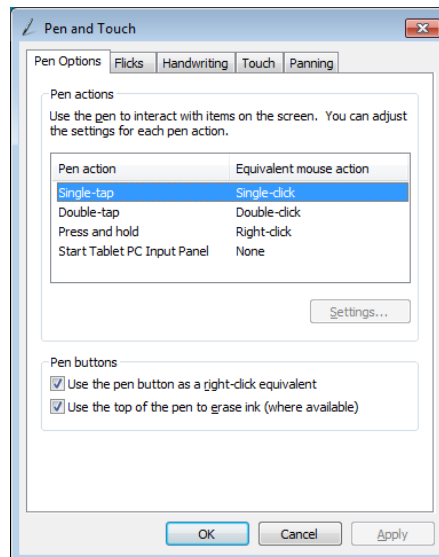

Configure the touch panel operation settings in the “Pen and Touch” window. For detailed settings, refer to the settings on each tab and Windows Help.

### 3. After completing settings, click “OK” to close the window.

## 4-3. Setting Touch Sound

The sound output when the screen is touched can be changed or turned off.

### 1. Open the Windows Control Panel.

The method for opening the Control Panel differs depending on the OS (see [page 24](#)).

### 2. Click “Hardware and Sound” - “Sound” - “Change system sounds”.

“Sound” window appears.

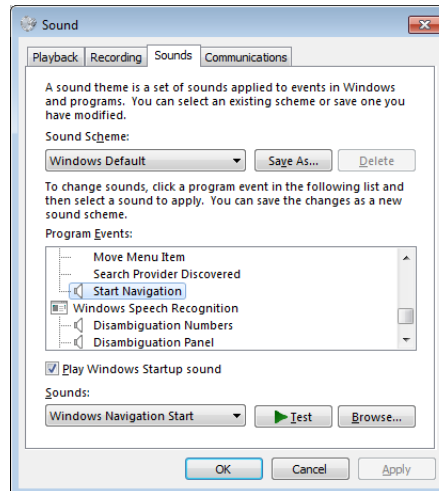

### 3. Select “Start Navigation” from the “Program Events” list.

### 4. Select the sound to output when the screen is touched from the “Sounds” pull-down menu.

---

#### Note

- Select “None” to turn off touch sound.
- 

### 5. Click “OK” to close the window.

# Chapter 5 Power Saving Functions

## 5-1. Setting Power Saving

This function allows you to set the monitor into the power saving mode according to the PC status. When the monitor has shifted to the power saving mode, the images on the screen are not displayed.

### Attention

- For the maximum power saving, it is recommended that the Power button be turned off.
- Five seconds before the monitor enters the power saving mode, it displays a preliminary message.

### Procedure

1. Choose "PowerManager" from the Adjustment menu, and press  $\odot$ .
2. Choose "Power Save" from "PowerManager", and press  $\odot$ .
3. Select "On" or "Off" with  $\leftarrow$  or  $\rightarrow$ .
4. Press  $\odot$  to exit.

### Power Saving System

#### At Analog signal input

This monitor complies with the "VESA DPM" standard.

PC		Monitor
ON		Operating
Power saving mode	STAND-BY SUSPENDED OFF	Power saving mode

#### At Digital signal input

This monitor complies with the "DVI DMPM" standard.

The monitor enters the power saving mode after five seconds in connection with the PC setting.

PC		Monitor
ON		Operating
Power saving mode		Power saving mode

### Exiting the power saving mode

If the monitor receives input, it automatically exits the power saving mode and returns to the normal display mode.

## 5-2. Setting the automatic power off function

This function allows you to specify whether to turn on / off the monitor automatically after a specified time has elapsed in the power saving mode.

### Adjustable range

Off, 0, 1, 2, 3, 4, 5, 10, 15, 20, 25, 30, 45 min, 1, 2, 3, 4, 5 h



### Procedure

1. Choose "PowerManager" from the Adjustment menu, and press  $\odot$ .
2. Choose "Eco Timer" from "PowerManager", and press  $\odot$ .
3. Select "Off" or time to turn off the monitor with  $\leftarrow$  or  $\rightarrow$ .
4. Press  $\odot$  to exit.

# Chapter 6 Troubleshooting

If a problem still remains after applying the suggested remedies, contact your EIZO representative.



## 6-1. No picture

Problem	Possible cause and remedy
<p><b>1. No picture</b></p> <ul style="list-style-type: none"> <li>None of the operation buttons light up.</li> </ul> <hr/> <ul style="list-style-type: none"> <li>Only the  button lights up orange.</li> <li>All of the operation buttons light up orange.</li> </ul>	<ul style="list-style-type: none"> <li>Check whether the power cord is connected properly.</li> <li>Turn the main power switch on.</li> <li>Turn off the main power, and then turn it on again a few minutes later.</li> </ul> <hr/> <ul style="list-style-type: none"> <li>Press .</li> <li>Adjust the brightness (brilliance) of the screen.</li> <li>Operate the mouse or keyboard.</li> <li>Check whether the PC is turned on.</li> </ul>
<p><b>2. The message below appears.</b></p> <ul style="list-style-type: none"> <li>This message appears when no signal is input. Example:</li> </ul> <div data-bbox="320 902 624 1108" data-label="Image"> </div> <hr/> <ul style="list-style-type: none"> <li>The message shows that the input signal is out of the specified frequency range. (Such signal frequency is displayed in magenta.) Example:</li> </ul> <div data-bbox="320 1256 624 1514" data-label="Image"> </div> <p>fD: Dot clock (Displayed only during digital signal input) fH: Horizontal scan frequency fV: Vertical scan frequency</p>	<p>This message appears when the signal is not input correctly even when the monitor functions properly.</p> <ul style="list-style-type: none"> <li>The message shown left may appear, because some PCs do not output the signal soon after power-on.</li> <li>Check whether the PC is turned on.</li> <li>Check whether the signal cable is connected properly.</li> <li>Switch the input signal (see <a href="#">“To switch among input signals”</a> (page 34)).</li> </ul> <hr/> <ul style="list-style-type: none"> <li>Check whether the PC is configured to meet the resolution and vertical scan frequency requirements of the monitor. (“Compatible Resolutions” in the Setup Manual.)</li> <li>Reboot the PC.</li> <li>Select an appropriate display mode using the graphics board’s utility. Refer to the User’s Manual of the graphics board for details.</li> </ul>

## 6-2. Imaging problems (for both digital and analog)

Problem	Possible cause and remedy
1. The screen is too bright or too dark.	<ul style="list-style-type: none"> <li>Use “Brilliance” in the Adjustment menu to adjust it. (The LCD monitor backlight has a limited life span. When the screen becomes dark or begins to flicker, contact your local dealer.)</li> </ul>
2. The screen suddenly became dark. / The “Brilliance” value in the Adjustment menu cannot be increased.	<ul style="list-style-type: none"> <li>The monitor always monitors its internal temperature. If the internal monitor reaches a high temperature and exceeds the specified value, the monitor will automatically enter the following state to decrease the temperature.               <ul style="list-style-type: none"> <li>The “Brilliance” setting is lowered</li> <li>The “Brilliance” setting cannot be increased</li> </ul>               This state will return to the original when the internal temperature decreases.             </li> <li>If the internal temperature increases further even after the “Brilliance” setting is decreased, a “WARNING” message is displayed and the monitor power is automatically turned off. (Power indicator flashes green.)</li> </ul>
3. Characters are blurred.	<ul style="list-style-type: none"> <li>Check whether the PC is configured to meet the resolution and vertical scan frequency requirements of the monitor. (“Compatible Resolutions” in the Setup Manual.)</li> <li>Use “Outline Enhancer” in the Adjustment menu to adjust it (see <a href="#">“To enhance outline of image” (page 17)</a>).</li> </ul>
4. Afterimages appear.	<ul style="list-style-type: none"> <li>Afterimages are particular to LCD monitors. Avoid displaying the same image for a long time.</li> <li>Use the screen saver or power saving function to avoid displaying the same image for extended periods of time.</li> </ul>
5. Green / red / blue / white dots or defective dots remain on the screen.	<ul style="list-style-type: none"> <li>This is due to LCD panel characteristics and is not a failure.</li> </ul>
6. Interference patterns or pressure marks remain on the screen.	<ul style="list-style-type: none"> <li>Leave the monitor with a white or black screen. The symptom may disappear.</li> </ul>
7. Noise appears on the screen.	<ul style="list-style-type: none"> <li>When entering the signals of HDCP system, the normal images may not be displayed immediately.</li> </ul>
8. Cloudiness cannot be removed even after wiping the screen. / There is dew condensation on the interior side of the glass.	<ul style="list-style-type: none"> <li>When cloudiness cannot be removed even by wiping the screen, dew condensation may have occurred on the interior side of the glass that protects the panel. In this case, turn on the monitor and display something on screen. The dew condensation will disappear after a while. Also, warming the glass using a hair dryer may make the dew condensation disappear more quickly. Dew condensation appearing like this on the interior side of the glass will not lead to product failure or degradation.</li> </ul>

## 6-3. Imaging problems (for analog only)

Problem	Possible cause and remedy
<p>1. Display position is incorrect.</p> 	<ul style="list-style-type: none"> <li>• Use “Position” in the Adjustment menu to correct the image position (see <a href="#">“To correct the screen position” (page 14)</a>).</li> <li>• If the problem persists, use the graphics board’s utility if available to change the display position.</li> </ul>
<p>2. Vertical bars appear on the screen or a part of the image is flickering.</p> 	<ul style="list-style-type: none"> <li>• Use “Clock” in the Adjustment menu to adjust it (see <a href="#">“To eliminate vertical bars” (page 14)</a>).</li> </ul>
<p>3. Whole screen is flickering or blurring.</p> 	<ul style="list-style-type: none"> <li>• Use “Phase” in the Adjustment menu to adjust it (see <a href="#">“To remove flickering or blurring” (page 14)</a>).</li> </ul>

## 6-4. Other problems

Problem	Possible cause and remedy
<p>1. The message below appears on screen.</p> 	<ul style="list-style-type: none"> <li>• This message appears when the monitor’s cooling fan is not operating correctly. Check the state of the cooling fan on the rear of the monitor.</li> </ul>
<p>2. The Adjustment menu does not appear.</p>	<ul style="list-style-type: none"> <li>• Check whether the operation lock function works (see <a href="#">“3-6. Locking Buttons” (page 21)</a>).</li> <li>• If the function is active, “Locked” is displayed on the screen.</li> </ul>
<p>3. The fan is noisy.</p>	<ul style="list-style-type: none"> <li>• This product is fitted with a cooling fan to keep the internal temperature from rising. Depending on the monitor’s location the fan may be audible when operating, but this is not a defect.</li> </ul>

## 6-5. Touch panel problems (for FDS1904T / FDU2603WT only)

Problem	Possible cause and remedy
1. Touch operation is disabled.	<ul style="list-style-type: none"> <li>• Check that the monitor and PC are connected with a USB or RS-232C cable.</li> <li>• Turn off and on the monitor.</li> <li>• Check that the power cord of the monitor and PC is connected to a grounded main outlet. Failure to ground the equipment may result in malfunction.</li> <li>• Perform touch panel sensitivity adjustment using TPOffset.</li> </ul>
2. Cursor position is not correct. / Cursor jumps.	<ul style="list-style-type: none"> <li>• Connect the monitor to the PC with the cable indicated in the Setup Manual. The touch panel may not work correctly if a conversion adapter is used.</li> <li>• Turn off and on the monitor.</li> <li>• Calibrate the screen again.</li> <li>• Check that the power cord of the monitor and PC is connected to a grounded main outlet. Failure to ground the equipment may result in malfunction.</li> <li>• Perform touch panel sensitivity adjustment using TPOffset.</li> <li>• Changing the position or angle of the monitor may cause the cursor to jump.</li> <li>• Keep metals away from the panel surface.</li> <li>• If the touch panel is dirty, the touch panel may not operate properly. See “Cleaning” (page 4) to clean the touch panel.</li> <li>• The spray for preventing static electricity may influence the sensitivity of the touch panel.</li> <li>• Do not touch the touch panel for 5 seconds after the PC starts up, after turning on the monitor, or after connecting the cable. Touching the touch panel too soon may cause incorrect cursor positioning or disable touch operation. If this occurs, either leave the touch panel untouched for approximately 2 minutes or turn the monitor off and on again. If the problem persists, calibrate the screen again.</li> </ul>
3. The cursor does not appear at the touched position and instead is displayed at a point-symmetric position with respect to the center of the screen.	<ul style="list-style-type: none"> <li>• Calibrate the screen again.</li> </ul>
4. Cursor is jittery. / Drawing lines are not straight and smooth.	<ul style="list-style-type: none"> <li>• Check that the power cord of the monitor and PC is connected to a grounded main outlet. Failure to ground the equipment may result in malfunction.</li> <li>• Perform touch panel sensitivity adjustment using TPOffset.</li> <li>• The influence of metal may cause jittery cursor.</li> <li>• When multiple monitors are placed close to each other, leave space between monitors.</li> </ul>
5. (If the OS being used is Windows 8.1 / Windows 8 / Windows 7) Calibration does not work correctly.	<ul style="list-style-type: none"> <li>• Reset the touch panel to the state before calibration (by clicking “Reset” in the “Display” tab of the “Tablet PC Settings” window accessible from the Windows Control Panel) and then calibrate the touch panel again.</li> </ul>
6. (If the OS being used is Windows 8.1 / Windows 8 / Windows 7) No touch-sound.	<ul style="list-style-type: none"> <li>• Sound is only output through the audio output terminal of the PC. To hear touch sound, connect speakers.</li> <li>• Sound is not output when touched positions are not assigned any functions.</li> </ul>

### Attention

- For details on TPOffset (software for adjusting touch panel sensitivity), see the TPOffset User’s Manual (on the CD-ROM).



# Chapter 7 Reference

## 7-1. Connecting Multiple PCs

The product has multiple connections to PCs and allows you to switch to one of the connections for display.

**Attention**

- It is assumed the touch panel monitor will be used with one computer. When the monitor is to be connected to multiple computers, connect a RS-232C cable to the computer used for touch operation (one unit only).

### Connection examples

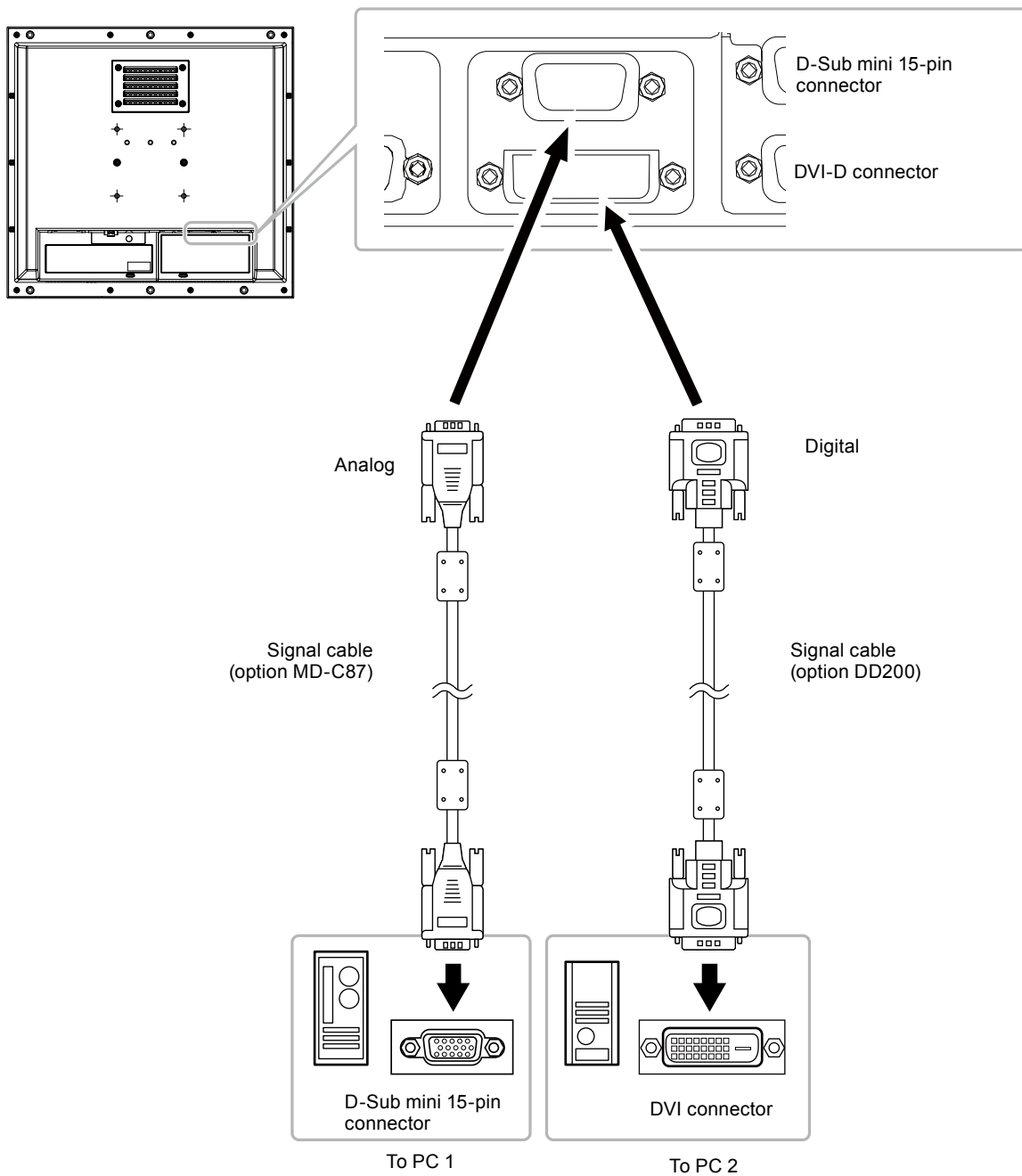

## ● To switch among input signals

### **Procedure**

1. Choose “Tools” from the Adjustment menu, and press **⏏**.
2. Choose “Input” from “Tools”, and press **⏏**.
3. Select “D-SUB” or “DVI” with **⏪** or **⏩**.
4. Press **⏏** to exit.

## ● To set input signal selection

Setting	Function
Auto	The monitor recognizes the connector through which PC signals are input. When a PC is turned off or enters the power saving mode, the monitor automatically displays another signal.
Manual	The monitor detects only the PC's signals currently displaying automatically. Select an active input signal in the Adjustment menu.

### **Procedure**

1. Choose “Tools” from the Adjustment menu, and press **⏏**.
2. Choose “Input Selection” from “Tools”, and press **⏏**.
3. Select “Auto” or “Manual” with **⏪** or **⏩**.
4. Press **⏏** to exit.

---

### **Note**

- When “Auto” is selected for “Input Selection”, the monitor’s power saving function works only when all PCs are in the power saving mode.
-

## 7-2. Displaying monitor information

### ● Displaying signal information

This function displays the information about the current input signals displayed.

#### **Procedure**

1. Choose “Tools” from the Adjustment menu, and press **⊙**.
2. Choose “Signal Info” from “Tools”, and press **⊙**.

The “Signal Info” appears.

(Example)

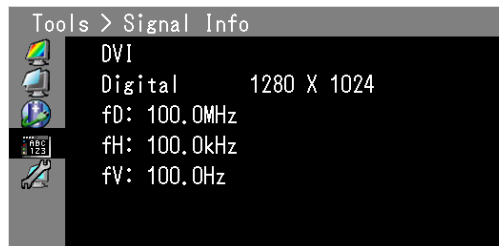

### ● Displaying monitor information

This function displays the information about the monitor.

#### **Procedure**

1. Choose “Tools” from the Adjustment menu, and press **⊙**.
2. Choose “Monitor Info” from “Tools”, and press **⊙**.

The “Monitor Info” appears.

The product name, serial number, DDC/CI settings, firmware version and usage time are displayed.

(Example)

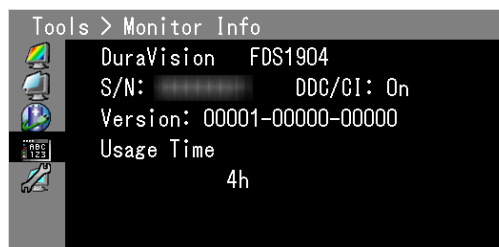

---

#### **Attention**

- The usage time is not always “0” when you purchase the monitor due to factory inspection.
-

## 7-3. How to Replace the Cooling Fan

The cooling fan in this product can be replaced according to the following procedure.

### Attention

- Be sure to follow the procedure when replacing the fan. Note that EIZO Corporation assumes no responsibility for any damages caused due to improper handling of this product.

### Note

- Please contact your local EIZO representative for replacement parts.

### Procedure

#### 1. Remove the monitor from its enclosure.

1. Remove the screws that secure the monitor to the enclosure.
2. Lay the LCD monitor on a soft cloth spread over on a stable surface with the panel surface facing down.

#### 2. Remove the fan cover.

Remove the four screws that secure the cover.

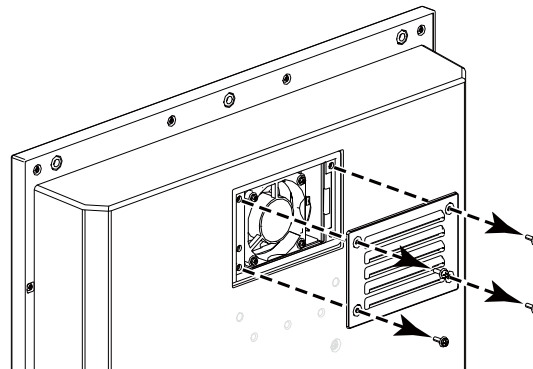

FDS1904 / FDS1904T

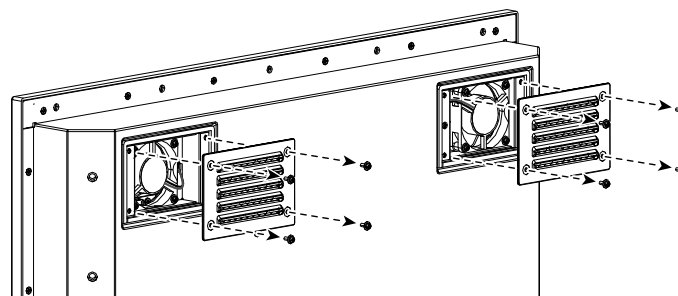

FDU2603W / FDU2603WT

### 3. Remove the fan.

1. Disconnect the cables connected to the monitor.
2. Remove the four screws that secure the fan.

**Attention**

- Make sure to hold the connector when removing the cable. Pulling on the cable may damage the connector.

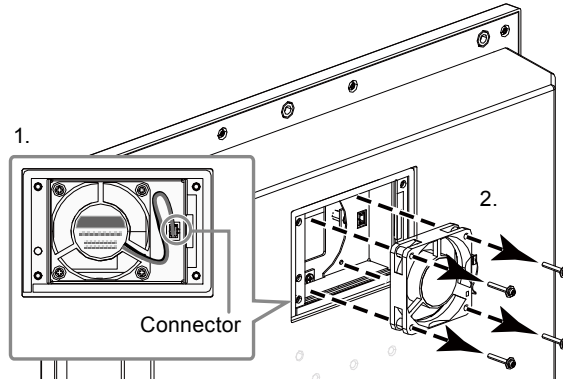

FDS1904 / FDS1904T

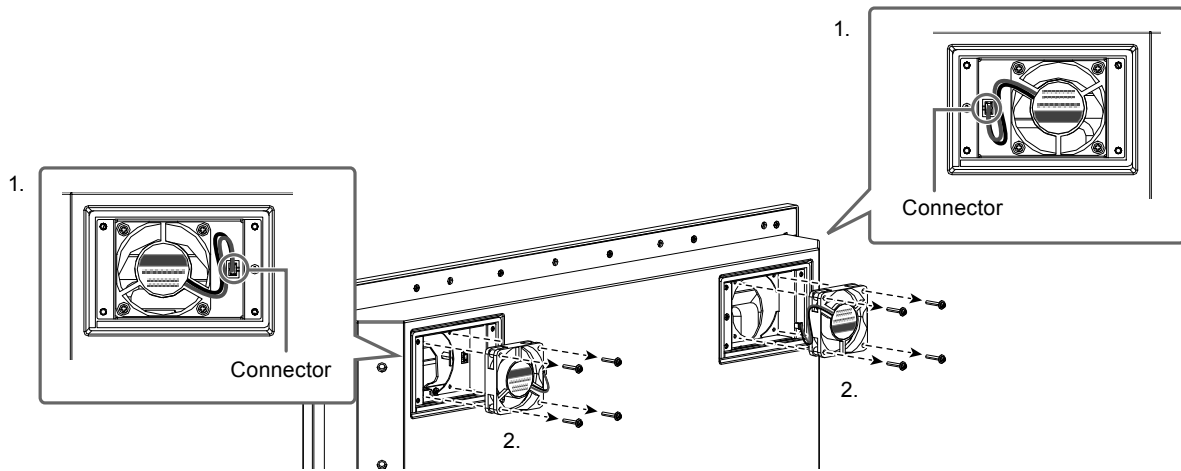

FDU2603W / FDU2603WT

## 4. Install the new fan.

### Attention

- Take care when handling the fan. Dropping or imparting physical shocks to the fan may damage it.
- Pay attention to the orientation of the fan when installing it.

1. Fix the fan to the monitor using the screws removed in step 3 (page 37) (recommended torque:  $8.0 \pm 2\text{kgf}\cdot\text{cm} / 0.78 \pm 0.2 \text{ N}\cdot\text{m}$ ).
2. Connect the cable to the monitor.  
Securely connect the connector to the monitor.

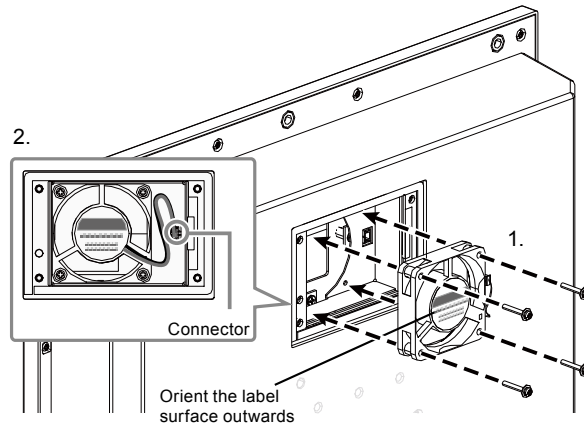

FDS1904 / FDS1904T

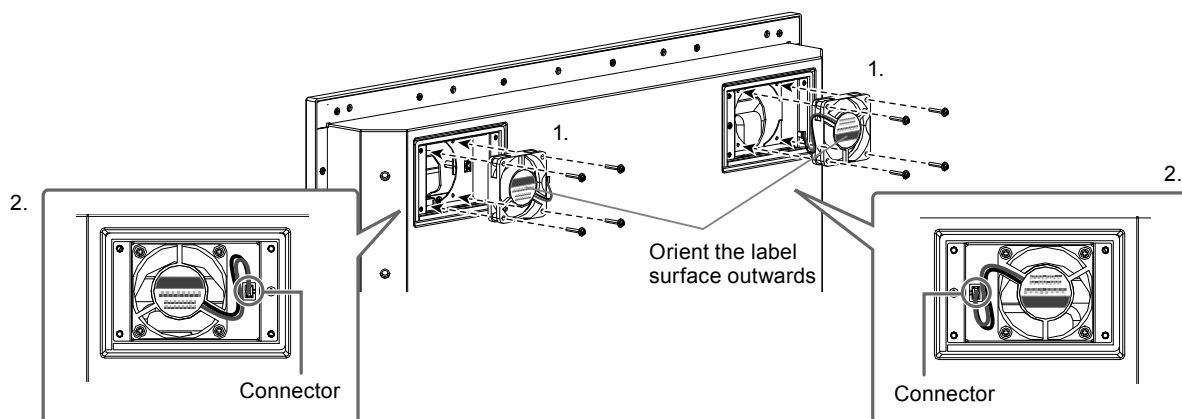

FDU2603W / FDU2603WT

## 5. Install the fan cover.

Fix the cover to the monitor using the screws removed in step 2 (page 36).

### Attention

- Orient the air outlets downwards when installing the cover.

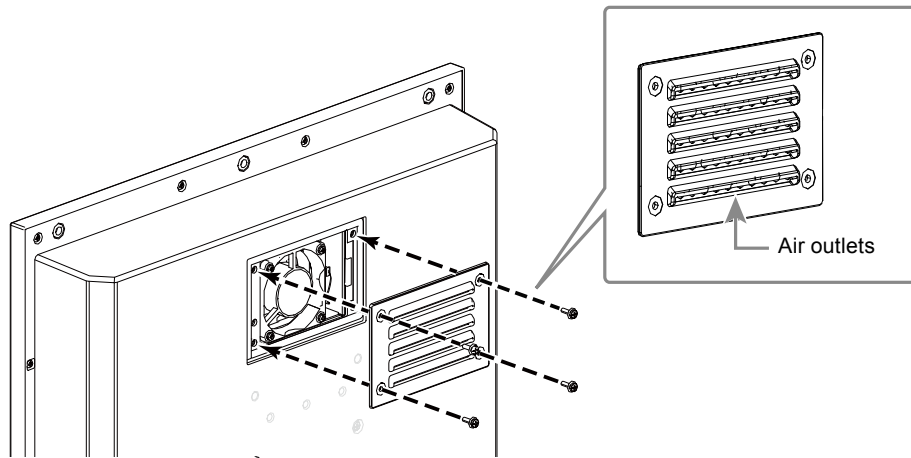

FDS1904 / FDS1904T

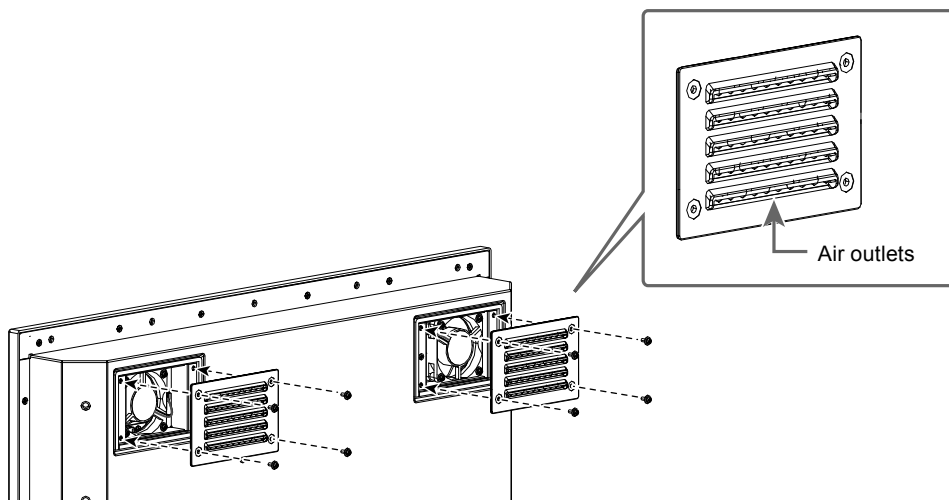

FDU2603W / FDU2603WT

## 6. Install the monitor into the enclosure.

## 7-4. Specifications

### ● FDS1904 / FDS1904-OP

LCD Panel	Type	VA			
	Backlight	LED			
	Size	48 cm (19.0 inch) (48.1 cm diagonal)			
	Native Resolution	1280 dots × 1024 lines			
	Display Size (H x V)	376.3 mm × 301.0 mm			
	Pixel Pitch	0.294 mm			
	Display Colors	Approx. 16.77 million colors			
	Viewing Angles (H / V, typical)	178° / 178°			
	Maximum brightness (brilliance)	FDS1904:	590 cd/m <sup>2</sup>		
		FDS1904-OP:	600 cd/m <sup>2</sup>		
	Contrast ratio (typical)	2000:1			
Response Time (typical)	20 ms (Black-white-black)				
Protective glass	Surface treatment	Anti-reflection			
	Surface hardness	5H			
Video Signals	Input Terminals	DVI-D connector × 1, D-Sub mini 15-pin × 1			
	Output terminal	D-Sub mini 15-pin × 1			
	Digital Scanning Frequency (H / V)	31 kHz - 64 kHz / 59Hz - 61Hz (720 × 400: 69Hz - 71Hz)			
	Analog Scanning Frequency (H / V)	31 kHz - 80 kHz / 56 Hz - 76Hz			
	Dot Clock	Digital	108 MHz		
		Analog	135 MHz		
Synchronous signal	Separate, TTL, positive / negative Composite, TTL, positive / negative Sync on Green, 0.5Vp-p, negative				
Communication	Input Terminals	RS-232C: D-Sub 9-pin (female)			
Power	Input	AC	Rating AC 100 - 240 V (Operating: AC 85 V - 264 V), 50/60 Hz, 0.65 A - 0.3 A		
		DC	Rating DC +24 V (Operating: +30% / -10%), 2.7 A (DC 24 V)		
	Maximum Power Consumption	64 W or less			
	Power Save Mode	AC	9.0 W or less	(When there is DVI input, no USB device is connected, and "Input Selection" is set to "Manual", and when DDC/CI is OFF)	
		DC	6.0 W or less		
	Standby Mode	AC	7.0 W or less	(When there is DVI input, no USB device is connected, and "Input Selection" is set to "Manual", and when DDC/CI is OFF)	
DC		5.0 W or less			
Physical Specifications	Dimensions	429 mm × 406 mm × 74.5 mm (excluding the projection)			
	Net Weight	FDS1904:	Approx. 5.9 kg		
		FDS1904-OP:	Approx. 6.2 kg		
Operating Environmental Requirements	Temperature:	-15°C to 55°C			
	Humidity	10% to 90% R.H. (no condensation)			
Transportation / Storage Environmental Requirements	Temperature	-20°C to 60°C			
	Humidity	10% to 92% R.H. (no condensation)			
Viewing distance (Recommended)	1014 mm or more (*Based on IEC 62288)				
Protection structure	Front: IP65, Rear: IP22 (Landscape only)				



## ● FDS1904T / FDS1904T-OP

LCD Panel	Type	VA		
	Backlight	LED		
	Size	48 cm (19.0 inch) (48.1 cm diagonal)		
	Resolution	1280 dots × 1024 lines		
	Display Size (H x V)	376.3 mm × 301.0 mm		
	Pixel Pitch	0.294 mm		
	Display Colors	Approx. 16.77 million colors		
	Viewing Angles (H / V, typical)	178° / 178°		
	Maximum brightness (brilliance)	FDS1904T:	540 cd/m <sup>2</sup>	
		FDS1904T-OP:	580 cd/m <sup>2</sup>	
Contrast ratio (typical)	2000:1			
Response Time (typical)	20 ms (Black-white-black)			
Touch Panel	Method	Projected capacitive technology		
	Communication method	USB, RS-232C (* Cannot be used at the same time.)		
	Surface treatment	Anti-reflection, Anti-fingerprint		
	Surface hardness	5H		
	OS	Microsoft Windows 8.1 (32 bit / 64 bit) Microsoft Windows 8 (32 bit / 64 bit) Microsoft Windows 7 Service Pack 1 (32 bit / 64 bit) Microsoft Windows XP Service Pack 3 (32 bit) (Not compatible with Mac OS)		
	Number of simultaneous touch points	Up to 5 (Microsoft Windows XP only supports single point touch)		
Video Signals	Input Terminals	DVI-D connector × 1, D-Sub mini 15-pin × 1		
	Output terminal	D-Sub mini 15-pin × 1		
	Digital Scanning Frequency (H / V)	31 kHz - 64 kHz / 59 Hz - 61 Hz (720 × 400: 69 Hz - 71 Hz)		
	Analog Scanning Frequency (H / V)	31 kHz - 80 kHz / 56Hz - 76Hz		
	Dot Clock	Digital	108 MHz	
		Analog	135 MHz	
Synchronous signal	Separate, TTL, positive / negative Composite, TTL, positive / negative Sync on Green, 0.5 Vp-p, negative			
Communication	Input Terminals	RS-232C:	D-Sub 9-pin (female)	
		RS-232C:	D-Sub 9-pin (male)	
USB	Port	Upstream port × 1		
	Standard	USB Specification Revision 2.0		
Power supply	Input	AC	Rating AC 100 - 240 V (Operating: AC 85 V - 264 V), 50/60 Hz, 0.65 A - 0.3 A	
		DC	Rating DC +24 V (Operating: +30% / -10%), 2.7 A (DC 24 V)	
	Maximum Power Consumption	64 W or less		
	Power Save Mode	AC	9.0 W or less	(When there is DVI input, no USB device is connected, and "Input Selection" is set to "Manual", and when DDC/CI is OFF)
		DC	6.0 W or less	
	Standby Mode	AC	7.0 W or less	(When there is DVI input, no USB device is connected, and "Input Selection" is set to "Manual", and when DDC/CI is OFF)
DC		5.0 W or less		

Physical Specifications	Dimensions	429 mm × 406 mm × 74.5 mm (excluding the projection)
	Net Weight	FDS1904T:        Approx. 6.4 kg
		FDS1904T-OP:    Approx. 6.7 kg
Operating Environmental Requirements	Temperature:	-15°C to 55°C
	Humidity	10% to 90% R.H. (no condensation)
Transportation / Storage Environmental Requirements	Temperature	-20°C to 60°C
	Humidity	10% to 92% R.H. (no condensation)
Viewing distance (Recommended)		1014 mm or more (*Based on IEC 62288)
Protection structure		Front: IP65, Rear: IP22 (Landscape only)

## ● FDU2603W / FDU2603W-OP

LCD Panel	Type	VA		
	Backlight	LED		
	Size	65 cm (25.5 inch) (64.8 cm diagonal)		
	Native Resolution	1920 dots × 1200 lines		
	Display Size (H x V)	550.0 mm × 343.8 mm		
	Pixel Pitch	0.2865 mm		
	Display Colors	Approx. 16.77 million colors		
	Viewing Angles (H / V, typical)	176° / 176°		
	Maximum brightness (brilliance)	FDU2603W:	490 cd/m <sup>2</sup>	
		FDU2603WT-OP:	500 cd/m <sup>2</sup>	
	Contrast ratio (typical)	1500:1		
Response Time (typical)	20 ms (Black-white-black)			
Protective glass	Surface treatment	Anti-reflection		
	Surface hardness	5H		
Video Signals	Input Terminals	DVI-D connector × 1, D-Sub mini 15-pin × 1		
	Output terminal	D-Sub mini 15-pin × 1		
	Digital Scanning Frequency (H / V)	31 kHz - 76 kHz / 59 Hz - 61 Hz (720 × 400: 69 Hz - 71 Hz)		
	Analog Scanning Frequency (H / V)	31 kHz - 81 kHz / 56 Hz - 76 Hz		
	Dot Clock	Digital	162 MHz	
		Analog	162 MHz	
Synchronous signal	Separate, TTL, positive / negative			
	Composite, TTL, positive / negative			
Communication	Input Terminals	RS-232C:	D-Sub 9-pin (female)	
Power	Input	AC	Rating AC 100 - 240 V (Operating: AC 85 V - 264 V), 50/60 Hz, 1.2 A - 0.6 A	
		DC	Rating DC +24 V (Operating: +30% / -10%), 4.5 A (DC 24 V)	
	Maximum Power Consumption	108 W or less		
	Power Save Mode	AC	10.0 W or less	
		DC	7.0 W or less	
	Standby Mode	AC	10.0 W or less	
		DC	7.0 W or less	
Physical Specifications	Dimensions	624 mm × 456 mm × 86 mm (excluding the projection)		
	Net Weight	FDU2603W:	Approx. 14.5 kg	
		FDU2603W-OP:	Approx. 14.9 kg	
Operating Environmental Requirements	Temperature:	-15°C to 55°C		
	Humidity	10% to 90% R.H. (no condensation)		
Transportation / Storage Environmental Requirements	Temperature	-20°C to 60°C		
	Humidity	10% to 90% R.H. (no condensation, wet bulb temperature ≤ 39 °C)		
Viewing distance (Recommended)	988 mm or more (*Based on IEC 62288)			
Protection structure	Front: IP65, Rear: IP22			

## ● FDU2603WT / FDU2603WT-OP

LCD Panel	Type	VA		
	Backlight	LED		
	Size	65 cm (25.5 inch) (64.8 cm diagonal)		
	Native Resolution	1920 dots × 1200 lines		
	Display Size (H x V)	550.0 mm × 343.8 mm		
	Pixel Pitch	0.2865 mm		
	Display Colors	Approx. 16.77 million colors		
	Viewing Angles (H / V, typical)	176° / 176°		
	Maximum brightness (brilliance)	FDU2603WT: 470 cd/m <sup>2</sup> FDU2603WT-OP: 500 cd/m <sup>2</sup>		
	Contrast ratio (typical)	1500:1		
	Response Time (typical)	20 ms (Black-white-black)		
Touch Panel	Method	Projected capacitive technology		
	Communication method	USB, RS-232C (* Cannot be used at the same time.)		
	Surface treatment	Anti-reflection		
	Surface hardness	5H		
	OS	Microsoft Windows 8.1 (32 bit / 64 bit) Microsoft Windows 8 (32 bit / 64 bit) Microsoft Windows 7 Service Pack 1 (32 bit / 64 bit) Microsoft Windows XP Service Pack 3 (32 bit) (Not compatible with Mac OS)		
	Number of simultaneous touch points	Up to 5 (Microsoft Windows XP only supports single point touch)		
Video Signals	Input Terminals	DVI-D connector × 1, D-Sub mini 15-pin × 1		
	Output terminal	D-Sub mini 15-pin × 1		
	Digital Scanning Frequency (H / V)	31 kHz - 76 kHz / 59 Hz - 61 Hz (720 × 400: 69 Hz - 71 Hz)		
	Analog Scanning Frequency (H / V)	31 kHz - 81 kHz / 56 Hz - 76 Hz		
	Dot Clock	Digital	162 MHz	
		Analog	162 MHz	
	Synchronous signal	Separate, TTL, positive / negative Composite, TTL, positive / negative Sync on Green, 0.3 Vp-p, negative		
Communication	Input Terminals	RS-232C:	D-Sub 9-pin (female)	
		RS-232C:	D-Sub 9-pin (male)	
USB	Port	Upstream port × 1		
	Standard	USB Specification Revision 2.0		
Power	Input	AC	Rating AC 100 - 240 V (Operating: AC 85 V - 264 V), 50/60 Hz, 1.2 A - 0.6 A	
		DC	Rating DC +24 V (Operating: +30% / -10%), 4.5 A (DC 24 V)	
	Maximum Power Consumption	108 W or less		
	Power Save Mode	AC	10.0 W or less	
		DC	7.0 W or less	
	Standby Mode	AC	10.0 W or less	
		DC	7.0 W or less	

Physical Specifications	Dimensions	624 mm × 456 mm × 86 mm (excluding the projection)
	Net Weight	FDU2603WT: Approx. 15.1 kg FDU2603WT-OP: Approx. 15.9 kg
Operating Environmental Requirements	Temperature:	-15°C to 55°C
	Humidity	10% to 90% R.H. (no condensation)
Transportation / Storage Environmental Requirements	Temperature	-20°C to 60°C
	Humidity	10% to 90% R.H. (no condensation, wet bulb temperature ≤ 39 °C)
Viewing distance (Recommended)		988 mm or more (*Based on IEC 62288)
Protection structure		Front: IP65, Rear: IP22

## Main Default Settings

Brilliance	FDS1904 / FDS1904T	1-Custom: 100% (255/255) 2-Day: 65% (166/255) 3-Dusk: 56% (144/255) 4-Night: 11% (28/255)
	FDU2603W / FDU2603WT	1-Custom: 100% (255/255) 2-Day: 67% (171/255) 3-Dusk: 60% (153/255) 4-Night: 11% (27/255)
Screen Size		Enlarged
Power Save		Off
Power Indicator		4
Eco Timer		Off
Language		English
Menu Position		Center
Input <sup>*1</sup>		D-SUB
Input Selection		Auto
Key Lock <sup>*1</sup>		Off
DDC/CI <sup>*1</sup>		On
Orientation <sup>*1</sup>		Landscape
Backlight Off Mode <sup>*1</sup>		On
ECDIS Indicator <sup>*1,*2</sup>		On

\*1 These functions cannot be initialized with the “All Reset” function (see [“3-9. Return To Default Setting”](#) (page 23)).

\*2 The ECDIS Indicator becomes active when the monitor display mode is set to “Day”, “Dusk” or “Night”.

## Outside Dimensions

### ● FDS1904 / FDS1904T

Unit: mm

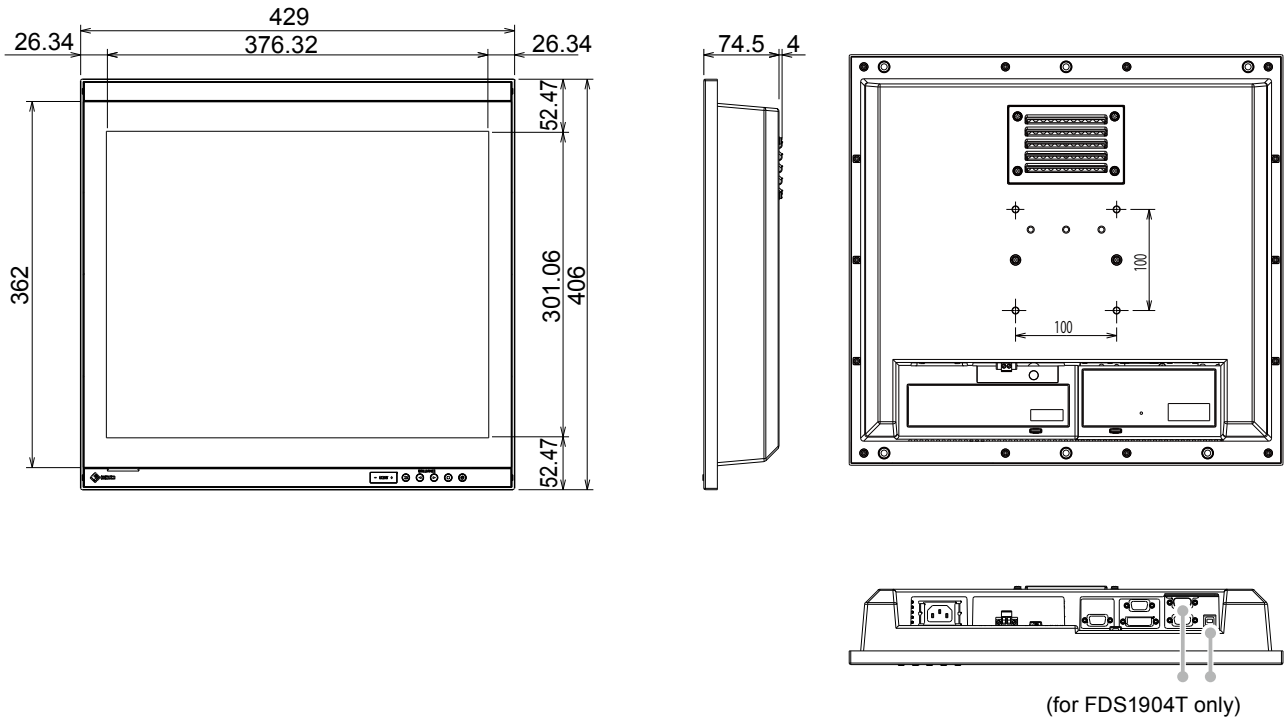

### ● FDU2603W / FDU2603WT

Unit: mm

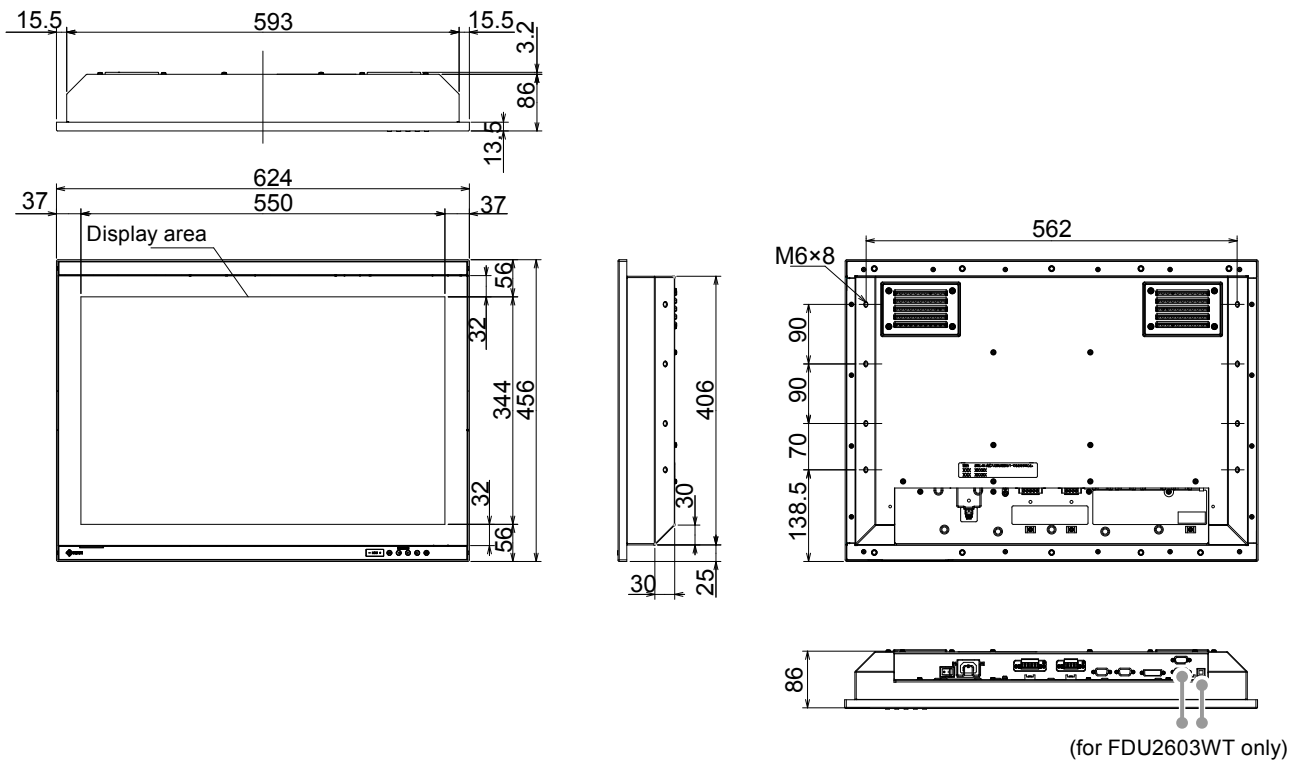

## ● Pin Assignment

### D-Sub mini 15-pin connector

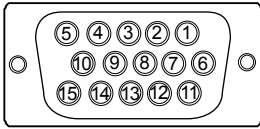

Pin No.	Signal	Pin No.	Signal	Pin No.	Signal
1	Red Video	6	Red Video Ground	11	Ground
2	Green Video	7	Green Video Ground	12	Data (SDA)
3	Blue Video	8	Blue Video Ground	13	H.Sync
4	Ground	9	NC	14	V.Sync
5	NC	10	Ground	15	Clock (SCL)

(NC: Not connected)

### DVI-D connector

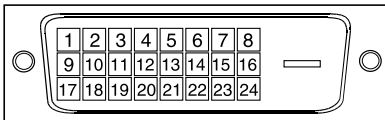

Pin No.	Signal	Pin No.	Signal	Pin No.	Signal
1	T.M.D.S. Data 2-	9	T.M.D.S. Data1-	17	T.M.D.S. Data0-
2	T.M.D.S. Data 2+	10	T.M.D.S. Data1+	18	T.M.D.S. Data0+
3	T.M.D.S. Data2/4 Shield	11	T.M.D.S. Data1/3 Shield	19	T.M.D.S. Data0/5 Shield
4	NC	12	NC	20	NC
5	NC	13	NC	21	NC
6	DDC Clock (SCL)	14	+5V Power	22	T.M.D.S. Clock shield
7	DDC Data (SDA)	15	Ground (return for +5V, Hsync and Vsync)	23	T.M.D.S. Clock+
8	Analog Vertical Sync	16	Hot Plug Detect	24	T.M.D.S. Clock-

(NC: Not connected)

### USB port

- Upstream (Series B)

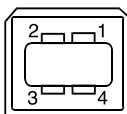

Pin No.	Signal	Remarks
1	VBUS	Cable power
2	-Data	Serial data
3	+Data	Serial data
4	Ground	Cable ground

## RS-232C port

- D-Sub 9-pin (female, for monitor control)

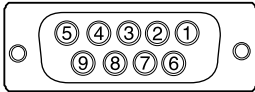

Pin No.	Signal	Pin No.	Signal	Pin No.	Signal
1	DCD	4	DTR	7	RTS
2	RXD	5	GND	8	CTS
3	TXD	6	DSR	9	RI

### Attention

- The monitor is the DCE side.
- Use a straight-through cable (male to female) to connect with the PC.

- D-Sub 9-pin (male, for touch panel control)

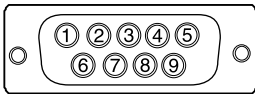

Pin No.	Signal	Pin No.	Signal	Pin No.	Signal
1	DCD	4	DTR	7	RTS
2	RXD	5	GND	8	CTS
3	TXD	6	DSR	9	RI

### Attention

- The monitor is the DTE side.
- Use a crossover cable (female to female) to connect with the PC.



## 7-5. Preset Timing

The following table shows factory preset analog signal timing:

### Attention

- Display position may be deviated depending on the PC connected, which may require screen adjustment using Adjustment menu.
- If a signal other than those listed in the table is input, adjust the screen using the Adjustment menu. However, screen display may still be incorrect even after the adjustment.
- When interlace signals are used, the screen cannot be displayed correctly even after screen adjustment using the Adjustment menu.

### FDS1904 / FDS1904T

Resolution	Frequency		
	Dot Clock: MHz	Horizontal:kHz	Vertical: Hz
640 × 480	25.18	31.47	59.94
640 × 480	31.50	37.86	72.81
640 × 480	31.50	37.50	75.00
720 × 400	28.32	31.47	70.09
800 × 600	36.00	35.16	56.25
800 × 600	40.00	37.88	60.32
800 × 600	50.00	48.08	72.19
800 × 600	49.50	46.88	75.00
1024 × 768	65.00	48.36	60.00
1024 × 768	75.00	56.48	70.07
1024 × 768	78.75	60.02	75.03
1152 × 864	108.00	67.50	75.00
1152 × 900	94.20	61.97	66.14
1152 × 900	107.50	71.86	76.20
1280 × 960	108.00	60.00	60.00
1280 × 1024	108.00	63.98	60.02
1280 × 1024	117.00	71.69	67.19
1280 × 1024	135.00	79.98	75.03

### FDU2603W / FDU2603WT

Resolution	Frequency		
	Dot Clock: MHz	Horizontal:kHz	Vertical: Hz
640 x 480	25.18	31.47	59.94
640 x 480	31.50	37.86	72.81
640 x 480	31.50	37.50	75.00
720 x 400	28.32	31.47	70.09
800 x 600	36.00	35.16	56.25
800 x 600	40.00	37.88	60.32
800 x 600	50.00	48.08	72.19
800 x 600	49.50	46.88	75.00
1024 x 768	65.00	48.36	60.00
1024 x 768	75.00	56.48	70.07
1024 x 768	78.75	60.02	75.03
1152 x 864	108.00	67.50	75.00
1152 x 900	94.20	61.97	66.14
1152 x 900	107.50	71.86	76.20
1280 x 960	108.00	60.00	60.00
1280 x 1024	108.00	63.98	60.02
1280 x 1024	117.00	71.69	67.19
1280 x 1024	135.00	79.98	75.03
1600 x 1200	162.00	75.00	60.00
1600 x 1200	130.25	74.00	59.92
1680 x 1050	146.25	65.29	59.95
1920 x 1200	154.00	74.04	59.95

# Chapter 8 Glossary

## Clock

The analog signal input monitor needs to reproduce a clock of the same frequency as the dot clock of the graphics system in use, when the analog signal is converted to a digital signal for image display. This is called clock adjustment. If the clock pulse is not set correctly, some vertical bars appear on the screen.

## DDC/CI (Display Data Channel/Command Interface)

VESA provides the standardization for the interactive communication of the setting information, etc. between a PC and the monitor.

## DVI (Digital Visual Interface)

DVI is a digital interface standard. DVI allows direct transmission of the PC's digital data without loss. This adopts the TMDS transmission system and DVI connectors. There are two types of DVI connectors. One is a DVI-D connector for digital signal input only. The other is a DVI-I connector for both digital and analog signal inputs.

## DVI DMPM (DVI Digital Monitor Power Management)

DVI DMPM is a digital interface power saving function. The "Monitor ON (operating mode)" and "Active Off (power saving mode)" are indispensable for DVI DMPM as the monitor's power mode.

## Gain

This is used to adjust each color parameter for red, green and blue. An LCD monitor displays the color by the light passing through the panel color filter. Red, green and blue are the three primary colors. All the colors on the screen are displayed by combining these three colors. The color tone can be changed by adjusting the light intensity (volume) passing through each color's filter.

## Gamma

Generally, the monitor brightness varies nonlinearly with the input signal level, which is called "Gamma Characteristic". A small gamma value produces a low-contrast image, while a large gamma value produces a highcontrast image.

## HDCP (High-bandwidth Digital Content Protection)

Digital signal coding system developed to copy-protect the digital contents, such as video, music, etc. This helps to transmit the digital contents safely by coding the digital contents sent via the DVI or HDMI connector on the output side and decoding them on the input side.

Any digital contents cannot be reproduced if both of the equipments on the output and input sides are not applicable to HDCP system.

## Phase

Phase means the sampling timing to convert the analog input signal to a digital signal. Phase adjustment is made to adjust the timing. It is recommended that phase adjustment be made after the clock is adjusted correctly.

## **Range Adjustment**

Range adjustment controls the signal output levels to display every color gradation. It is recommended that range adjustment be made before color adjustment.

## **Resolution**

The LCD panel consists of numerous pixels of specified size, which are illuminated to form images. This monitor consists of horizontal 1280 pixels and 1024 vertical pixels (FDS1904 / FDS1904T), or horizontal 1920 pixels and 1200 vertical pixels (FDU2603W / FDU2603WT). At a resolution of 1280 × 1024 (FDS1904 / FDS1904T) or 1920 × 1200 (FDU2603W / FDU2603WT), all pixels are illuminated as a full screen (1:1).

## **Sync-on-Green**

A composite horizontal and vertical signal sync for the green signal in RGB. Typically, monitors use 5 signals, one for red, green and blue, and one for each horizontal and vertical sync. Sync-on-green monitors utilize three connections, one for red, one for blue and two synced horizontal and vertical signals that are counted as one green video signal.

## **Temperature**

Color temperature is a method to measure the white color tone, generally indicated in degrees Kelvin. The screen becomes reddish at a low temperature, and bluish at a high temperature, like the flame temperature.

5000 K: Slightly reddish white

6500 K: White referred to as daylight-balanced color

9300 K: Slightly bluish white

## **TMDS (Transition Minimized Differential Signaling)**

A signal transmission system for digital interface.

## **VESA DPM (Video Electronics Standards Association - Display Power Management)**

VESA specifications achieve increased energy efficiency for computer monitors. This involves standardization of signals sent from the computer (graphics board).

DPM defines the status of signals transmitted between the computer and monitor.

# Appendix

## Trademark

The terms HDMI and HDMI High-Definition Multimedia Interface, and the HDMI Logo are trademarks or registered trademarks of HDMI Licensing, LLC in the United States and other countries.

VESA is a registered trademark of Video Electronics Standards Association.

Acrobat, Adobe, Adobe AIR, and Photoshop are registered trademarks of Adobe Systems Incorporated in the United States and other countries.

AMD Athlon and AMD Opteron are trademarks of Advanced Micro Devices, Inc.

Apple, ColorSync, eMac, iBook, iMac, iPad, Mac, MacBook, Macintosh, Mac OS, PowerBook, and QuickTime are registered trademarks of Apple Inc.

ColorMunki, Eye-One, and X-Rite are registered trademarks or trademarks of X-Rite Incorporated in the United States and/or other countries.

ColorVision and ColorVision Spyder2 are registered trademarks of DataColor Holding AG in the United States.

Spyder3 and Spyder4 are trademarks of DataColor Holding AG.

ENERGY STAR is a registered trademark of the United States Environmental Protection Agency in the United States and other countries.

GRACoL and IDEAlliance are registered trademarks of International Digital Enterprise Alliance.

NEC is a registered trademark of NEC Corporation.

PC-9801 and PC-9821 are trademarks of NEC Corporation.

NextWindow is a trademark of NextWindow Ltd.

Intel, Intel Core, Pentium, and Thunderbolt are trademarks of Intel Corporation in the U.S. and/or other countries.

PowerPC is a registered trademark of International Business Machines Corporation.

PlayStation is a registered trademark of Sony Computer Entertainment Inc.

PSP and PS3 are trademarks of Sony Computer Entertainment Inc.

RealPlayer is a registered trademark of RealNetworks, Inc.

TouchWare is a trademark of 3M Touch Systems, Inc.

Windows, Windows Media, Windows Vista, SQL Server, Xbox 360, and Internet Explorer are registered trademarks of Microsoft Corporation in the United States and other countries.

YouTube is a registered trademark of Google Inc.

Firefox is a registered trademark of the Mozilla Foundation.

Kensington and MicroSaver are registered trademarks of ACCO Brands Corporation.

EIZO, the EIZO Logo, ColorEdge, DuraVision, FlexScan, FORIS, RadiCS, RadiForce, RadiNET, Raptor, and ScreenManager are registered trademarks of EIZO Corporation in Japan and other countries.

ColorNavigator, EcoView NET, EIZO EasyPIX, EIZO ScreenSlicer, i•Sound, Screen Administrator, and UniColor, and Re/Vue are trademarks of EIZO Corporation.

All other company and product names are trademarks or registered trademarks of their respective owners.

## License / Copyright

A round gothic bold bit map font designed by Ricoh is used for the characters displayed on this product.

## Testing Standard

This product complies with the IEC60945 4th edition standard.

Equipment category: b) protected from the weather

## Type approval of ship classification

This product is pending approval for the following types of ship classifications.

- NK (Nippon Kaiji Kyokai)
- DNV (Det Norske Veritas)
- ABS (American Bureau of Shipping)
- LR (Lloyd's Register of Shipping)

\* For the latest information on approvals for ship classifications, please refer to our website.

<http://www.eizoglobal.com>

## CE

### For Europe, etc. (rated 200-240 Vac) Only

#### **Warning**

This is a Class A product. In a domestic environment this product may cause radio interference in which case the user may be required to take adequate measures.

#### **Warnung**

Bei dem Gerät handelt es sich um ein Klasse-A-Produkt. Bei Betrieb des Geräts in Wohnumgebungen ist gegebenenfalls durch entsprechende Maßnahmen dafür zu sorgen, dass eine Störung des Radio- und Fernsehempfangs vermieden wird.

#### **Avertissement**

Cet appareil est de classe A. Il est susceptible de créer des interférences radio dans un environnement domestique, dans ce cas l'utilisateur devra prendre les mesures appropriées.

# LIMITED WARRANTY

---

## LIMITED WARRANTY

EIZO Corporation (hereinafter referred to as “**EIZO**”) and distributors authorized by EIZO (hereinafter referred to as the “**Distributors**”) warrant, subject to and in accordance with the terms of this limited warranty (hereinafter referred to as the “**Warranty**”), to the original purchaser (hereinafter referred to as the “**Original Purchaser**”) who purchased the product specified in this document (hereinafter referred to as the “**Product**”) from EIZO or Distributors, that EIZO and Distributors shall, at their sole discretion, either repair or replace the Product at no charge if the Original Purchaser becomes aware within the Warranty Period (defined below) that the Product malfunctions or is damaged in the course of normal use of the Product in accordance with the description in the instruction manual attached to the Product (hereinafter referred to as the “**User’s Manual**”).

The period of this Warranty is three (3) years from the date of purchase of the Product (hereinafter referred to as the “**Warranty Period**”). EIZO and Distributors shall bear no liability or obligation with regard to the Product in relation to the Original Purchaser or any third parties other than as provided under this Warranty.

EIZO and Distributors will cease to hold or store any parts of the Product upon expiration of ten (10) years after the production of such parts is discontinued. In repairing the monitor, EIZO and Distributors will use renewal parts which comply with our QC standards.

The Warranty is valid only in the countries or territories where the Distributors are located. The Warranty does not restrict any legal rights of the Original Purchaser.

Notwithstanding any other provision of this Warranty, EIZO and Distributors shall have no obligation under this Warranty whatsoever in any of the cases as set forth below:

- (a) Any defect of the Product caused by freight damage, modification, alteration, abuse, misuse, accident, incorrect installation, disaster, faulty maintenance and/or improper repair by third party other than EIZO and Distributors;
- (b) Any incompatibility of the Product due to possible technical innovations and/or regulations;
- (c) Any deterioration of the sensor;
- (d) Any deterioration of display performance caused by the deterioration of expendable parts such as the LCD panel and/or backlight, etc. (e.g. changes in brightness, changes in brightness uniformity, changes in color, changes in color uniformity, defects in pixels including burnt pixels, etc.);
- (e) Any defect of the Product caused by placement in a location where it may be affected by strong vibration or shocks;
- (f) Any defect of the Product caused by external equipment;
- (g) Any defect of the Product on which the original serial number has been altered or removed;
- (h) Any defect of the Product caused by liquid leaking from battery;
- (i) Any normal deterioration of the product, particularly that of consumables, accessories, and/or attachments (e.g. buttons, rotating parts, cables, User’s Manual, etc.); and
- (j) Any deformation, discoloration, warp, and/or rust of the exterior of the product including that of the surface of the LCD panel.

To obtain service under the Warranty, the Original Purchaser must deliver the Product, freight prepaid, in its original package or other adequate package affording an equal degree of protection, assuming the risk of damage and/or loss in transit, to the local Distributor. The Original Purchaser must present proof of purchase of the Product and the date of such purchase when requesting services under the Warranty.

The Warranty Period for any replaced and/or repaired product under this Warranty shall expire at the end of the original Warranty Period.

EIZO OR DISTRIBUTORS ARE NOT RESPONSIBLE FOR ANY DAMAGE TO, OR LOSS OF, DATA OR OTHER INFORMATION STORED IN ANY MEDIA OR ANY PART OF ANY PRODUCT RETURNED TO EIZO OR DISTRIBUTORS FOR REPAIR.

EIZO AND DISTRIBUTORS MAKE NO FURTHER WARRANTIES, EXPRESSED OR IMPLIED, WITH RESPECT TO THE PRODUCT AND ITS QUALITY, PERFORMANCE, MERCHANTABILITY OR FITNESS FOR ANY PARTICULAR USE. IN NO EVENT SHALL EIZO OR DISTRIBUTORS BE LIABLE FOR ANY INCIDENTAL, INDIRECT, SPECIAL, CONSEQUENTIAL OR OTHER DAMAGE WHATSOEVER (INCLUDING, WITHOUT LIMITATION, DAMAGES FOR LOSS OF PROFIT, BUSINESS INTERRUPTION, LOSS OF BUSINESS INFORMATION, OR ANY OTHER PECUNIARY LOSS) ARISING OUT OF THE USE OR INABILITY TO USE THE PRODUCT OR IN ANY CONNECTION WITH THE PRODUCT, WHETHER BASED ON CONTRACT, TORT, NEGLIGENCE, STRICT LIABILITY OR OTHERWISE, EVEN IF EIZO OR DISTRIBUTORS HAVE BEEN ADVISED OF THE POSSIBILITY OF SUCH DAMAGES. THIS EXCLUSION ALSO INCLUDES ANY LIABILITY WHICH MAY ARISE OUT OF THIRD PARTY CLAIMS AGAINST THE ORIGINAL PURCHASER. THE ESSENCE OF THIS PROVISION IS TO LIMIT THE POTENTIAL LIABILITY OF EIZO AND DISTRIBUTORS ARISING OUT OF THIS LIMITED WARRANTY AND/OR SALES.

## BEGRENZTE GARANTIE

EIZO Corporation (im Weiteren als „**EIZO**“ bezeichnet) und die Vertragsimporteure von EIZO (im Weiteren als „**Vertrieb(e)**“ bezeichnet) garantieren dem ursprünglichen Käufer (im Weiteren als „**Erstkäufer**“ bezeichnet), der das in diesem Dokument vorgegebene Produkt (im Weiteren als „**Produkt**“ bezeichnet) von EIZO oder einem Vertrieb erworben hat, gemäß den Bedingungen dieser beschränkten Garantie (im Weiteren als „**Garantie**“ bezeichnet), dass EIZO und der Vertrieb nach eigenem Ermessen das Produkt entweder kostenlos reparieren oder austauschen, falls der Erstkäufer innerhalb der Garantiefrist (weiter unten festgelegt) eine Fehlfunktion bzw. Beschädigung des Produkts feststellt, die während des normalen Gebrauchs des Produkts gemäß den Anweisungen des zum Lieferumfang des Produkts gehörenden Benutzerhandbuchs (im Weiteren als „**Benutzerhandbuch**“ bezeichnet) aufgetreten ist.

Die Dauer der Garantieleistung (im Weiteren als „**Garantiefrist**“ bezeichnet) beträgt drei (3) Jahre ab dem Kaufdatum des Produkts. EIZO und die Vertriebe übernehmen über den Rahmen dieser Garantie hinaus hinsichtlich des Produkts keinerlei Haftung oder Verpflichtung dem Erstkäufer oder Dritten gegenüber.

EIZO und seine Distributoren halten im Produkt verbaute Teile für einen Zeitraum von zehn (10) Jahren vorrätig, nachdem die Produktion dieser Bauteile eingestellt wurde. EIZO und seine Vertriebspartner verpflichten sich, bei einer etwaigen Reparatur des Monitors ausschließlich Produkte gemäß den EIZO-Qualitätssicherungsstandards zu verwenden.

Diese Garantie gilt nur in Ländern oder Gebieten, in denen sich Vertriebe befinden. Die gesetzlichen Gewährleistungsrechte des Erstkäufers gegenüber dem Verkäufer werden durch diese Garantie nicht berührt.

EIZO und die Vertriebe besitzen im Rahmen dieser Garantie keinerlei Verpflichtung in den folgenden Fällen:

- (a) Produktdefekte, die auf Frachtschäden, Modifikation, Nachgestaltung, Missbrauch, Fehlbedienung, Unfälle, unsachgemäße Installation, Naturkatastrophen, fehlerhafte Wartung und/oder unsachgemäße Reparatur durch eine andere Partei als EIZO und die Vertriebe zurückzuführen sind.
- (b) Eine Inkompatibilität des Produkts aufgrund von technischen Neuerungen und/oder neuen Bestimmungen, die nach dem Kauf in Kraft treten.
- (c) Jegliche Verschlechterung des Sensors.
- (d) Jegliche Verschlechterung der Bildschirmleistung, die durch Verschleißteile wie das LCD-Panel und/oder die Hintergrundbeleuchtung usw. hervorgerufen werden (z.B. Veränderungen von Helligkeit oder Helligkeitsverteilung, Veränderungen von Farbe oder Farbverteilung, Pixeldefekte einschließlich von durchgebrannten Pixeln usw.).
- (e) Produktdefekte, die durch Platzierung an einer Stelle verursacht werden, wo das Produkt von starker Vibration oder Schocks betroffen sein könnte.
- (f) Produktdefekte, die durch externe Geräte verursacht werden.
- (g) Jeglicher Defekt eines Produkts, dessen ursprüngliche Seriennummer geändert oder entfernt wurde.
- (h) Produktdefekte, die durch Austritt von Batterieflüssigkeit verursacht werden.
- (i) Normale Abnutzung des Produkts, insbesondere von Verbrauchsteilen, Zubehörteilen und/oder Beilagen (z.B. Tasten, drehbare Teile, Kabel, Benutzerhandbuch usw.); sowie
- (j) Verformungen, Verfärbungen, Verziehungen und/oder Rost am Produktäußeren, einschließlich der Oberfläche des LCD-Panels.

Bei Inanspruchnahme der Garantieleistung ist der Erstkäufer verpflichtet, das Produkt auf eigene Kosten und in der Originalverpackung bzw. einer anderen geeigneten Verpackung, die einen gleichwertigen Schutz gegen Transportschäden bietet, an den örtlichen Vertrieb zu übersenden, wobei der Erstkäufer das Transportrisiko gegenüber Schäden und/oder Verlust trägt. Zum Zeitpunkt der Inanspruchnahme der Garantieleistung muss der Erstkäufer einen Verkaufsbeleg vorweisen, auf dem das Kaufdatum angegeben ist.

Die Garantiefrist für ein im Rahmen dieser Garantie ausgetauschtes und/oder repariertes Produkt erlischt nach Ablauf der ursprünglichen Garantiefrist.

EIZO ODER DIE EIZO-VERTRAGSIMPORTEURE HAFTEN NICHT FÜR ZERSTÖRTE DATENBESTÄNDE ODER DIE KOSTEN DER WIEDERBESCHAFFUNG DIESER DATENBESTÄNDE AUF JEDLICHEN DATENTRÄGERN ODER TEILEN DES PRODUKTS, DIE IM RAHMEN DER GARANTIE BEI EIZO ODER DEN EIZO-VERTRAGSIMPORTEUREN ZUR REPARATUR EINGEREICHT WURDEN.

EIZO UND DIE EIZO-VERTRAGSIMPORTEURE GEBEN WEDER EXPLIZITE NOCH IMPLIZITE GARANTIEEN IN BEZUG AUF DIESES PRODUKT UND SEINE QUALITÄT, LEISTUNG, VERKÄUFLICHKEIT ODER EIGNUNG FÜR EINEN BESTIMMTEN ZWECK. AUF KEINEN FALL SIND EIZO ODER DIE EIZO-VERTRAGSIMPORTEURE VERANTWORTLICH FÜR JEDLICHE ZUFÄLLIGE, INDIREKTE, SPEZIELLE, FOLGE- ODER ANDERE SCHÄDEN JEDLICHER ART (EINSCHLIESSLICH OHNE JEDE BEGRENZUNG SCHÄDEN BEZÜGLICH PROFITVERLUST, GESCHÄFTSUNTERBRECHUNG, VERLUST VON GESCHÄFTSINFORMATION ODER JEDLICHE ANDEREN FINANZIELLEN EINBUSSEN), DIE DURCH DIE VERWENDUNG DES PRODUKTES ODER DIE UNFÄHIGKEIT ZUR VERWENDUNG DES PRODUKTES ODER IN JEDLICHER BEZIEHUNG MIT DEM PRODUKT, SEI ES BASIEREND AUF VERTRAG, SCHADENSERSATZ, NACHLAESSIGKEIT, STRIKTE HAFTPFLICHT ODER ANDEREN FORDERUNGEN ENTSTEHEN, AUCH WENN EIZO UND DIE EIZO-VERTRAGSIMPORTEURE IM VORAUS ÜBER DIE MÖGLICHKEIT SOLCHER SCHÄDEN INFORMIERT WURDEN. DIESER AUSSCHLUSS ENTHÄLT AUCH JEDE HAFTPFLICHT, DIE AUS FORDERUNGEN DRITTER GEGEN DEN ERSTKÄUFER ENTSTEHEN KANN. ZWECK DIESER KLAUSEL IST ES, DIE HAFTUNG VON EIZO UND DEN VERTRIEBEN GEGENÜBER FORDERUNGEN ZU BEGRENZEN, DIE AUS DIESER BESCHRÄNKTEN GARANTIE UND/ODER DEM VERKAUF ENTSTEHEN KÖNNEN.



## GARANTIE LIMITÉE

EIZO Corporation (ci-après dénommé « **EIZO** ») et les distributeurs autorisés par EIZO (ci-après dénommés « **Distributeurs** »), sous réserve et conformément aux termes de cette garantie limitée (ci-après dénommée « **Garantie** »), garantissent à l'acheteur initial (ci-après dénommé « **Acheteur initial** ») du produit spécifié dans la présente (ci-après dénommé « **Produit** ») acheté auprès d'EIZO ou de Distributeurs agréés EIZO, que EIZO et ses Distributeurs auront pour option de réparer ou remplacer gratuitement le Produit si l'Acheteur initial constate, pendant la Période de garantie (définie ci-dessous), qu'il y a un dysfonctionnement ou que le Produit a subi un dommage dans le cadre d'une utilisation normale du Produit conformément à la description du mode d'emploi qui accompagne le Produit (ci-après dénommé « **Manuel d'utilisation** »).

La période de cette Garantie est de trois (3) ans à partir de la date d'achat du Produit (ci-après dénommée « **Période de Garantie** »). EIZO et ses Distributeurs déclinent toute responsabilité ou obligation concernant ce Produit face à l'Acheteur initial ou à toute autre personne à l'exception de celles stipulées dans la présente Garantie.

EIZO et ses distributeurs cesseront de conserver ou d'entreposer toute pièce du produit au terme d'un délai de dix (10) ans à compter de l'arrêt de la production des pièces concernées. Pour réparer le moniteur, EIZO et ses distributeurs utiliseront des pièces de rechange conformes à nos normes de contrôle qualité.

La Garantie est valable uniquement dans les pays ou les territoires où se trouvent les Distributeurs. La Garantie ne limite aucun des droits reconnus par la loi à l'Acheteur initial.

Nonobstant toute autre clause de cette Garantie, EIZO et ses Distributeurs n'auront d'obligation dans le cadre de cette Garantie pour aucun des cas énumérés ci-dessous :

- (a) Tout défaut du Produit résultant de dommages occasionnés lors du transport, d'une modification, d'une altération, d'un abus, d'une mauvaise utilisation, d'un accident, d'une installation incorrecte, d'un désastre, d'un entretien et/ou d'une réparation incorrects effectués par une personne autre que EIZO ou ses Distributeurs ;
- (b) Toute incompatibilité du Produit résultant d'améliorations techniques et/ou réglementations possibles ;
- (c) Toute détérioration du capteur ;
- (d) Toute détérioration des performances d'affichage causée par la détérioration des éléments consommables tels que le panneau LCD et/ou le rétroéclairage, etc. (par exemple des changements de luminosité, des changements de l'uniformité de la luminosité, des modifications de couleur, des changements de l'uniformité des couleurs, des défauts de pixels y compris des pixels brûlés, etc.);
- (e) Tout défaut du Produit causé par le placement dans un endroit où il pourrait être affecté par de fortes vibrations ou chocs ;
- (f) Tout défaut du Produit causé par un appareil externe ;
- (g) Tout défaut d'un Produit sur lequel le numéro de série original a été altéré ou supprimé ;
- (h) Tout défaut du Produit causé par un écoulement du liquide contenu dans les piles ;
- (i) Toute détérioration normale du Produit, particulièrement celle des consommables, des accessoires et/ou des pièces reliées au Produit (touches, éléments pivotants, câbles, Manuel d'utilisation etc.), et
- (j) Toute déformation, décoloration, gondolage et/ou rouille de l'extérieur du Produit, y compris celle de la surface du panneau LCD.

Pour bénéficier d'un service dans le cadre de cette Garantie, l'Acheteur initial doit renvoyer le Produit port payé, dans son emballage d'origine ou tout autre emballage approprié offrant un degré de protection équivalent, au Distributeur local, et assumer la responsabilité des dommages et/ou perte possibles lors du transport. L'Acheteur initial doit présenter une preuve d'achat du Produit comprenant sa date d'achat pour bénéficier de ce service dans le cadre de la Garantie.

La Période de garantie pour tout Produit remplacé et/ou réparé dans le cadre de cette Garantie expirera à la fin de la Période de garantie initiale.

EIZO OU SES DISTRIBUTEURS NE SAURAIENT ÊTRE TENUS RESPONSABLES DES DOMMAGES OU PERTES DE DONNÉES OU D'AUTRES INFORMATIONS STOCKÉES DANS UN MÉDIA QUELCONQUE OU UNE AUTRE PARTIE DU PRODUIT RENVOYÉ À EIZO OU AUX DISTRIBUTEURS POUR RÉPARATION.

AUCUNE AUTRE GARANTIE, EXPLICITE OU TACITE, N'EST OFFERTE PAR EIZO ET SES DISTRIBUTEURS CONCERNANT LE PRODUIT ET SES QUALITÉS, PERFORMANCES, QUALITÉ MARCHANDE OU ADAPTATION À UN USAGE PARTICULIER. EN AUCUN CAS, EIZO OU SES DISTRIBUTEURS NE SERONT RESPONSABLES DES DOMMAGES FORTUITS, INDIRECTS, SPÉCIAUX, INDUITS, OU DE TOUT AUTRE DOMMAGE QUEL QU'IL SOIT (Y COMPRIS, SANS LIMITATION, LES DOMMAGES RÉSULTANT D'UNE PERTE DE PROFIT, D'UNE INTERRUPTION D'ACTIVITÉS, D'UNE PERTE DE DONNÉES COMMERCIALES, OU DE TOUT AUTRE MANQUE À GAGNER) RÉSULTANT DE L'UTILISATION OU DE L'INCAPACITÉ D'UTILISER LE PRODUIT OU AYANT UN RAPPORT QUELCONQUE AVEC LE PRODUIT, QUE CE SOIT SUR LA BASE D'UN CONTRAT, D'UN TORT, D'UNE NÉGLIGENCE, D'UNE RESPONSABILITÉ STRICTE OU AUTRE, MÊME SI EIZO OU SES DISTRIBUTEURS ONT ÉTÉ AVERTIS DE LA POSSIBILITÉ DE TELS DOMMAGES. CETTE LIMITATION INCLUT AUSSI TOUTE RESPONSABILITÉ QUI POURRAIT ÊTRE SOULEVÉE LORS DES RÉCLAMATIONS D'UN TIERS CONTRE L'ACHETEUR INITIAL. L'ESSENCE DE CETTE CLAUSE EST DE LIMITER LA RESPONSABILITÉ POTENTIELLE DE EIZO ET DE SES DISTRIBUTEURS RÉSULTANT DE CETTE GARANTIE LIMITÉE ET/OU DES VENTES.



## GARANTÍA LIMITADA

EIZO Corporation (en lo sucesivo “**EIZO**”) y sus distribuidores autorizados (en lo sucesivo los “**Distribuidores**”), con arreglo y de conformidad con los términos de esta garantía limitada (en lo sucesivo la “**Garantía**”), garantizan al comprador original (en lo sucesivo el “**Comprador original**”) que compró el producto especificado en este documento (en lo sucesivo el “**Producto**”) a EIZO o a sus Distribuidores, que EIZO y sus Distribuidores, a su propio criterio, repararán o sustituirán el Producto de forma gratuita si el Comprador original detecta dentro del periodo de la Garantía (indicado posteriormente) que el Producto no funciona correctamente o que se ha averiado durante el uso normal del mismo de acuerdo con las indicaciones del manual de instrucciones suministrado con el Producto (en lo sucesivo el “**Manual del usuario**”).

El periodo de esta Garantía es de tres (3) años a partir de la fecha de compra del Producto (en adelante designado como el “**Periodo de Garantía**”). EIZO y sus Distribuidores no tendrán ninguna responsabilidad ni obligación con respecto al Producto para con el Comprador original ni con terceros que no sean las estipuladas en la presente Garantía.

EIZO y sus Distribuidores dejarán de conservar o almacenar repuestos del Producto una vez pasados diez (10) años desde que dejen de fabricarse dichos repuestos. Para la reparación del monitor, EIZO y los distribuidores utilizarán repuestos que cumplan con nuestros estándares de control de calidad.

La Garantía es válida sólo en los países y territorios donde están ubicados los Distribuidores. La Garantía no restringe ningún derecho legal del Comprador original.

A pesar de las estipulaciones de esta Garantía, EIZO y sus Distribuidores no tendrán obligación alguna bajo esta Garantía en ninguno de los casos expuestos a continuación:

- (a) Cualquier defecto del Producto causado por daños en el transporte, modificación, alteración, abuso, uso incorrecto, accidente, instalación incorrecta, desastre, mantenimiento incorrecto y/o reparación indebida realizada por un tercero que no sea EIZO o sus Distribuidores.
- (b) Cualquier incompatibilidad del Producto debida a posibles innovaciones técnicas y/o reglamentaciones.
- (c) Cualquier deterioro del sensor.
- (d) Cualquier deterioro en el rendimiento de la visualización causado por fallos en las piezas consumibles como el panel LCD y/o la "Backlight", etc. (p. ej. cambios de brillo, cambios de uniformidad del brillo, cambios de color, cambios de uniformidad del color, defectos de píxeles, incluyendo píxeles muertos, etc.).
- (e) Cualquier defecto del Producto provocado por su colocación en un lugar donde pueda verse afectado por fuertes vibraciones o sacudidas.
- (f) Cualquier defecto del Producto causado por un equipo externo.
- (g) Cualquier defecto del Producto en el que haya sido alterado o borrado el número de serie original.
- (h) Cualquier defecto del Producto casusado por fugas de líquido de las pilas.
- (i) Cualquier deterioro normal del Producto, y en particular de las piezas consumibles, accesorios y demás (p. ej. botones, piezas giratorias, cables, Manual del usuario, etc.).
- (j) Cualquier deformación, decoloración, alabeo y/u oxidación del exterior del Producto incluida la superficie del panel LCD.

Para obtener servicio en los términos de esta Garantía, el Producto deberá ser enviado por el Comprador original, a su Distribuidor local, con el transporte previamente pagado, en el embalaje original u otro embalaje adecuado que ofrezca el mismo grado de protección, asumiendo el riesgo de daños y/o pérdida del Producto durante el transporte. El Comprador original deberá presentar un comprobante de compra del Producto en el que se refleje la fecha de compra del mismo cuando lo solicite el servicio de Garantía.

El Periodo de garantía para cualquier Producto reemplazado y/o reparado en los términos de esta Garantía expirará al vencer el Periodo de garantía original.

EIZO O LOS DISTRIBUIDORES AUTORIZADOS DE EIZO NO SE RESPONSABILIZAN DE NINGÚN DAÑO O PÉRDIDA QUE PUEDAN SUFRIR LOS DATOS U OTRA INFORMACIÓN ALMACENADA EN CUALQUIER MEDIO O CUALQUIER PARTE DE CUALQUIER PRODUCTO DEVUELTO A EIZO O A LOS DISTRIBUIDORES DE EIZO PARA SU REPARACIÓN.

EIZO Y LOS DISTRIBUIDORES AUTORIZADOS DE EIZO NO OFRECEN NINGUNA OTRA GARANTÍA, IMPLÍCITA NI EXPLÍCITA, CON RESPECTO AL PRODUCTO Y A SU CALIDAD, RENDIMIENTO, COMERCIABILIDAD E IDONEIDAD PARA CUALQUIER USO EN PARTICULAR. EN NINGÚN CASO SERÁN EIZO O LOS DISTRIBUIDORES AUTORIZADOS DE EIZO RESPONSABLES DE NINGÚN DAÑO EMERGENTE, INDIRECTO, ESPECIAL, INHERENTE O CUALQUIERA QUE SEA (INCLUYENDO, SIN LIMITACIÓN, DAÑOS POR LUCRO CESANTE, INTERRUPCIÓN DE LA ACTIVIDAD COMERCIAL, PÉRDIDA DE INFORMACIÓN COMERCIAL O CUALQUIER OTRA PÉRDIDA PECUNIARIA) QUE SE DERIVE DEL USO O IMPOSIBILIDAD DE USO DEL PRODUCTO O EN RELACIÓN CON EL PRODUCTO, YA SEA BASADO EN CONTRATO, POR AGRAVIO, NEGLIGENCIA, ESTRICTA RESPONSABILIDAD O CUALQUIERA QUE SEA, AUN CUANDO SE HAYA ADVERTIDO A EIZO O A LOS DISTRIBUIDORES DE EIZO DE LA POSIBILIDAD DE TALES DAÑOS. ESTA EXCLUSIÓN TAMBIÉN ABARCA CUALQUIER RESPONSABILIDAD QUE PUEDA DERIVARSE DE RECLAMACIONES HECHAS POR UN TERCERO CONTRA EL COMPRADOR ORIGINAL. LA ESENCIA DE ESTA ESTIPULACIÓN ES LIMITAR LA RESPONSABILIDAD POTENCIAL DE EIZO Y LOS DISTRIBUIDORES QUE PUDIERA DERIVARSE DE ESTA GARANTÍA LIMITADA Y/O VENTAS.

## GARANZIA LIMITATA

EIZO Corporation (a cui si farà riferimento da qui in poi con “**EIZO**”) ed i Distributori autorizzati da EIZO (a cui si farà riferimento da qui in poi con “**Distributori**”) garantiscono, secondo i termini di questa garanzia limitata (a cui si farà riferimento da qui in poi con “**Garanzia**”) all’acquirente originale (a cui si farà riferimento da qui in poi con “**Acquirente originale**”) che ha acquistato il prodotto specificato in questo documento (a cui si farà riferimento da qui in poi con “**Prodotto**”) da EIZO o dai suoi Distributori, che EIZO e i distributori, a loro discrezione, ripareranno o sostituiranno il Prodotto senza addebito se l’Acquirente originale trova, entro il periodo della Garanzia (definito sotto), che il Prodotto malfunziona e si è danneggiato nel corso del suo normale utilizzo osservando le indicazioni del manuale di istruzioni allegato al Prodotto (a cui si farà riferimento da qui in poi con “**Manuale utente**”).

Il periodo di questa Garanzia è di tre (3) anni dalla data di acquisto del Prodotto (a cui si farà riferimento da qui in poi con “**Periodo di Garanzia**”). EIZO e i suoi Distributori non si assumono alcuna responsabilità e non hanno alcun obbligo riguardo al Prodotto verso l’Acquirente originale o terzi diversi da quelli relativi a questa Garanzia.

Presso EIZO e i relativi distributori, è garantita una disponibilità a magazzino dei componenti di ricambio del prodotto fino a un massimo di dieci (10) anni, allo scadere dei quali la produzione degli stessi sarà definitivamente cessata. Per la riparazione del monitor, EIZO e i Distributori utilizzeranno parti di ricambio conformi ai nostri standard di controllo della qualità.

La Garanzia è valida soltanto nei paesi dove ci sono i Distributori EIZO. La Garanzia non limita alcun diritto legale dell’Acquirente originale.

Indipendentemente da qualsiasi altra condizione di questa Garanzia, EIZO e i suoi Distributori non avranno alcun obbligo derivante da questa Garanzia in ognuno dei casi elencati di seguito:

- (a) Qualsiasi difetto del Prodotto causato da danni di trasporto, modifiche, alterazioni, abusi, usi impropri, incidenti, installazione errata, calamità, manutenzione errata e/o riparazioni improprie eseguite da terze parti che non siano EIZO o i suoi Distributori.
- (b) Qualsiasi incompatibilità del Prodotto dovuta a possibili innovazioni tecniche e/o normative.
- (c) Qualsiasi deterioramento del sensore.
- (d) Qualsiasi deterioramento delle prestazioni dello schermo causato dal deterioramento delle parti consumabili, come il pannello LCD e/o la retroilluminazione, ecc. (per esempio: i cambiamenti di luminosità, cambiamenti di uniformità della luminosità, i cambiamenti di colore, i cambiamenti di uniformità del colore, i difetti dei pixel, inclusi i pixel bruciati, ecc.).
- (e) Qualsiasi difetto del Prodotto dovuto alla sua collocazione in un luogo che può assoggettarlo a forti vibrazioni o urti.
- (f) Qualsiasi difetto del Prodotto causato da apparecchiature esterne.
- (g) Qualsiasi difetto del Prodotto in cui il numero di serie originale sia stato alterato o rimosso.
- (h) Qualsiasi difetto del Prodotto causato dalla fuoriuscita di liquido dalle pile.
- (i) Qualsiasi normale deterioramento del Prodotto, in particolar modo nelle sue parti di consumo, accessori, e/o attacchi (per esempio: tasti, parti rotanti, cavi, Manuale dell’utente, ecc.).
- (j) Qualsiasi tipo di deformazione, scolorimento, alterazione e/o arrugginimento dell’involucro esterno del Prodotto inclusa la superficie del pannello LCD.

Per ricevere assistenza tecnica con questa Garanzia, l’Acquirente originale deve inviare il Prodotto, con trasporto pre-pagato, nella sua confezione originale o altra confezione adeguata che fornisce un livello analogo di protezione, assumendosi il rischio di danni e/o perdita in transito, al Distributore locale. L’Acquirente originale deve presentare la prova di acquisto che stabilisce la data di acquisto del Prodotto quando richiede servizio sotto Garanzia.

Il Periodo di garanzia per qualsiasi Prodotto sostituito e/o riparato sotto questa Garanzia scade alla fine del Periodo di garanzia originale.

EIZO O I SUOI DISTRIBUTORI NON SONO RESPONSABILI PER QUALSIASI DANNO O PERDITA DI DATI O ALTRE INFORMAZIONI MEMORIZZATI SU QUALSIASI SUPPORTO O QUALSIASI PARTE DI QUALSIASI PRODOTTO INVIATO A EIZO O I SUOI DISTRIBUTORI PER RIPARAZIONI.

EIZO E I SUOI DISTRIBUTORI NON OFFRONO ALCUNA GARANZIA ADDIZIONALE, IMPLICITA O ESPLICITA, RIGUARDO IL PRODOTTO E LA SUA QUALITÀ, PRESTAZIONI, VENDIBILITÀ O APPROPRIATEZZA PER QUALSIASI USO PARTICOLARE. IN NESSUN CASO EIZO O I DISTRIBUTORI EIZO AUTORIZZATI SARANNO RESPONSABILI PER QUALSIASI DANNO ACCIDENTALE, INDIRETTO, SPECIALE, CONSEGUENTE O DI QUALSIASI ALTRA NATURA (INCLUSI, SENZA LIMITI, DANNI PER PERDITA DI PROFITTI, INTERRUZIONE DELLE ATTIVITÀ, PERDITA DI INFORMAZIONI D’AFFARI O QUALSIASI ALTRA PERDITA PECUNIARIA) DERIVANTI DALL’USO O DALL’IMPOSSIBILITÀ DI USARE IL PRODOTTO O IN QUALSIASI RELAZIONE AL PRODOTTO, SIA SU BASE DI CONTRATTO, TORTO, NEGLIGENZA, STRETTA RESPONSABILITÀ O ALTRIMENTI, ANCHE SE EIZO O I DISTRIBUTORI EIZO AUTORIZZATI SONO STATI AVVERTITI DELLA POSSIBILITÀ DI TALI DANNI. QUESTA ESCLUSIONE INCLUDE ANCHE QUALSIASI RESPONSABILITÀ CHE POSSA INSORGERE DA RECLAMI DI TERZI CONTRO L’ACQUIRENTE ORIGINALE. L’ESSENZA DI QUESTO PROVVEDIMENTO È LIMITARE LA RESPONSABILITÀ POTENZIALE DI EIZO E DEI DISTRIBUTORI DERIVANTE DA QUESTA GARANZIA LIMITATA E/O DALLE VENDITE.

## BEGRÄNSAD GARANTI

EIZO Corporation (nedan kallat "**EIZO**") och EIZOs auktoriserade distributörer (nedan kallade "**Distributörer**") garanterar i enlighet med villkoren i denna begränsade garanti (nedan kallad "**Garantin**") den ursprunglige köparen (nedan kallad den "**Ursprunglige köparen**") som köpte den i dokumentet specificerade produkten (nedan kallad "**Produkten**") från EIZO eller Distributörer, att EIZO eller Distributörer enligt eget gottfinnande kostnadsfritt antingen reparera eller byta ut den defekta Produkten om den Ursprunglige köparen inom Garantiperioden (definieras nedan) upptäcker att Produkten fungerar felaktigt eller skadas under normal användning av Produkten i enlighet med beskrivningen i bruksanvisningen (nedan kallad "**Bruksanvisning**").

Garantiperioden är begränsad till tre (3) år från datumet för Produktens inköp (häri kallad "**Garantiperioden**"). EIZO och Distributörer ska inte under några villkor ha något annat ansvar än vad som anges i denna garanti gällande Produkten i relation till den Ursprunglige köparen eller tredje part.

EIZO och Distributörer får inte inneha eller lagerhålla någon del av Produkten när tio (10) år har förflutit efter att produktionen av sådana delar har upphört. Nät skärmen repareras använder EIZO och distributörer reservdelar som uppfyller våra kvalitetsstandarder.

Garantin är endast giltig i de länder där det finns Distributörer. Garantin begränsar inte några av den Ursprunglige köparens lagstadgade rättigheter.

Oavsett andra villkor i denna garanti ska inte EIZO Distributörer under några villkor ha något ansvar i något av de fall som beskrivs nedan:

- (a) När någon bristfällighet hos Produkten kan härledas till att ha uppstått vid frakt, modifiering, ändring, felaktigt handhavande, olycka, felaktig installation, katastrof, felaktigt underhåll och/eller felaktig reparation utförd av tredje part annan än EIZO och Distributörer.
- (b) Alla former av inkompatibilitet hos Produkten på grund av möjliga tekniska innovationer och/eller bestämmelser.
- (c) Alla försämringar av sensorn.
- (d) Alla försämringar av bildens prestanda beroende på förbrukningsdelar så som LCD-panel och/eller bakgrundsbelysning etc. (t.ex. ändringar i ljusstyrka, jämnhet i ljusstyrka, färg, färgjämnhet, defekta pixlar och/eller fast lysande pixlar etc.).
- (e) Alla defekter hos Produkten som orsakats av placering på en plats där den kan påverkas av kraftiga vibrationer eller stötar.
- (f) Alla defekter hos Produkten som orsakats av extern utrustning.
- (g) Alla defekter hos Produkten på vilken det ursprungliga serienumret har ändrats eller avlägsnats.
- (h) Alla produktfel som orsakas av vätska som läcker från batteriet.
- (i) All normal försämring av Produkten, speciellt förbrukningsartiklar, tillbehör och/eller yttre delar (t.ex. knappar, roterande delar, kablar, Bruksanvisningen etc.).
- (j) Varje deformation, missfärgning, skevhet och/eller rost av Produktens yttre inklusive ytan på LCD-panelen.

För att erhålla service under denna garanti måste den Ursprunglige köparen (med hänseende till risken för skada och/eller förlust under transport) leverera Produkten till närmaste Distributör med förebetalad frakt, i dess ursprungliga förpackning eller annan fullgod förpackning som ger likvärdigt skydd. Den Ursprunglige köparen måste kunna visa inköpsbevis för Produkten som klagör Produktens inköpsdatum vid begäran av garantiservice.

Garantiperioden för alla utbytta och/eller reparerade produkter under denna garanti skall upphöra vid utgången av den ursprungliga Garantiperioden.

**EIZO ELLER DISTRIBUTÖRER ÄR INTE ANSVARIGA FÖR NÅGON FORM AV SKADA ELLER FÖRLUST AV DATA ELLER ANNAN INFORMATION SOM HAR LAGRATS I NÅGON FORM AV MEDIA ELLER ANNAN DEL AV NÅGON PRODUKT SOM HAR RETURNERATS TILL EIZO ELLER DISTRIBUTÖRER FÖR REPARATION.**

**EIZO OCH DISTRIBUTÖRERNA GARANTERAR INGET, UTTRYCKLIGEN ELLER UNDERFÖRSTÅTT, VAD BETRÄFFAR PRODUKTEN OCH DESS KVALITET, PRESTANDA, SÄLJBARHET ELLER LÄMPLIGHET FÖR NÅGON FORM AV SPECIELL ANVÄNDNING. UNDER INGA OMSTÄNDIGHETER SKALL EIZO ELLER DISTRIBUTÖRERNA HÅLLAS ANSVARIGA FÖR NÅGRA SOM HELST UNDERORDNADE, INDIREKTA, SPECIELLA, DÄRAV FÖLJANDE ELLER ÖVRIGA SKADOR (INKLUSIVE, UTAN BEGRÄNSNING TILL, SKADOR FÖR FÖRLUST AV INKOMST, AVBRUTEN AFFÄRSRÖRELSE, FÖRLUST AV AFFÄRSINFORMATION ELLER ANNAN SÄRSKILD FÖRLUST) SOM UPPSTÅTT SOM ETT RESULTAT AV ANVÄNDNING ELLER OFÖRMÅGA ATT ANVÄNDA PRODUKTEN ELLER I NÅGON FORM AV ANSLUTNING TILL PRODUKTERNA, VARE SIG DETTA GRUNDAS PÅ KONTRAKT, ÅTALBAR HANDLING, FÖRSUMLIGHET, ANSVARSSKYLDIGHET ELLER ANNAT, ÄVEN OM EIZO ELLER DISTRIBUTÖRERNA HAR INFORMERATS BETRÄFFANDE MÖJLIGHET ATT SÅDANA SKADOR FÖRELIGGER. DETTA UNDANTAG OMFATTAR ÄVEN ALL FORM AV ANSVARSSKYLDIGHET SOM KAN UPPSTÅ GENOM EN TREDJE PARTS ANSPRÅK GENTEMOT DEN URSPRUNGLIGE KÖPAREN. GRUNDBESTÄNDSDELEN I BESTÄMMELEN ÄR ATT BEGRÄNSA DET EVENTUELLA ANSVARSTAGANDET FÖR EIZO OCH DISTRIBUTÖRERNA SOM KAN UPPSTÅ GENOM DENNA BEGRÄNSADE GARANTI OCH/ELLER FÖRSÄLJNING.**

## ΠΕΡΙΟΡΙΣΜΕΝΗ ΕΓΓΥΗΣΗ

Η EIZO Corporation (στο εξής «**EIZO**») και οι διανομείς που εξουσιοδοτεί η EIZO (στο εξής «**Διανομείς**») παρέχουν εγγύηση, υποκείμενη και σύμφωνα με τους όρους της παρούσας περιορισμένης εγγύησης (στο εξής «**Εγγύηση**»), στον αρχικό αγοραστή (στο εξής «**Αρχικός Αγοραστής**») ο οποίος αγόρασε το προϊόν που καθορίζεται στο παρόν έγγραφο (στο εξής «**Προϊόν**») από την EIZO ή τους Διανομείς, η οποία εξασφαλίζει ότι η EIZO και οι Διανομείς, σύμφωνα με τη διακριτή ευχέρειά τους, είτε θα επισκευάσουν είτε θα αντικαταστήσουν το Προϊόν χωρίς χρέωση εάν ο Αρχικός Αγοραστής αντιληφθεί εντός της Περιόδου Εγγύησης (ορίζεται κατωτέρω) ότι το Προϊόν δυσλειτουργεί ή έχει υποστεί βλάβη κατά τη διάρκεια κανονικής χρήσης του Προϊόντος σύμφωνα με την περιγραφή στο εγχειρίδιο χρήσης που συνοδεύει το Προϊόν (στο εξής «**Εγχειρίδιο Χρήστη**»).

Η περίοδος της παρούσας Εγγύησης είναι τρία (3) έτη από την ημερομηνία αγοράς του Προϊόντος (στο εξής «**Περίοδος Εγγύησης**»). Η EIZO και οι Διανομείς δεν φέρουν καμία ευθύνη ή υποχρέωση όσον αφορά το Προϊόν σε σχέση με τον Αρχικό Αγοραστή ή οποιοδήποτε τρίτο μέρος, ούτε άλλη ευθύνη διαφορετική από αυτήν που παρέχεται στην παρούσα Εγγύηση.

Η EIZO και οι Διανομείς θα παύσουν να διατηρούν ή να αποθηκεύουν τυχόν εξαρτήματα του Προϊόντος κατόπιν της λήξης δέκα (10) ετών μετά τη διακοπή της παραγωγής τέτοιων εξαρτημάτων. Κατά την επισκευή της οθόνης, η EIZO και οι Διανομείς θα χρησιμοποιήσουν ανταλλακτικά επισκευής που συμμορφώνονται με τα πρότυπά μας για τη Διασφάλιση Ποιότητας.

Η Εγγύηση ισχύει μόνο σε χώρες ή περιοχές όπου βρίσκονται οι Διανομείς. Η Εγγύηση δεν περιορίζει οποιαδήποτε νόμιμα δικαιώματα του Αρχικού Αγοραστή.

Λαμβανομένης υπόψη κάθε διάταξης της παρούσας Εγγύησης, η EIZO και οι Διανομείς δεν θα έχουν καμία απολύτως υποχρέωση σύμφωνα με την παρούσα Εγγύηση σε οποιαδήποτε από τις περιπτώσεις που διατυπώνονται κατωτέρω:

- (α) Τυχόν ελάττωμα του Προϊόντος που προκαλείται από ζημιά κατά τη μεταφορά, τροποποίηση, αλλαγή, κατάχρηση, λανθασμένη χρήση, ατύχημα, λανθασμένη εγκατάσταση, καταστροφή, εσφαλμένη συντήρηση ή/και λανθασμένη επισκευή από τρίτο μέρος εκτός της EIZO και των Διανομέων,
- (β) Τυχόν ασυμβατότητα του Προϊόντος λόγω πιθανών τεχνικών καινοτομιών ή/και κανονισμών,
- (γ) Τυχόν επιδείνωση του αισθητήρα,
- (δ) Τυχόν επιδείνωση της απόδοσης οθόνης που προκαλείται από τη φθορά αναλώσιμων εξαρτημάτων όπως της οθόνης LCD ή/και του φωτός υποβάθρου, κτλ. (π.χ. αλλαγές στη φωτεινότητα, αλλαγές στην ομοιομορφία φωτεινότητας, αλλαγές στο χρώμα, αλλαγές στην ομοιομορφία χρώματος, ελαττώματα σε pixel περιλαμβανομένων των καμένων pixel, κτλ.),
- (ε) Τυχόν ελάττωμα του Προϊόντος που οφείλεται στην τοποθέτησή του σε θέση όπου μπορεί να επηρεαστεί από ισχυρούς κραδασμούς ή κρούσεις,
- (στ) Τυχόν ελάττωμα του Προϊόντος που προκαλείται από εξωτερικό εξοπλισμό,
- (ζ) Τυχόν ελάττωμα του Προϊόντος στο οποίο έχει τροποποιηθεί ή αφαιρεθεί ο γνήσιος αριθμός σειράς,
- (η) Τυχόν ελάττωμα του Προϊόντος που προκαλείται από διαρροή υγρού από την μπαταρία,
- (θ) Τυχόν φυσιολογική φθορά του προϊόντος, ιδιαίτερα αυτής των αναλώσιμων, των αξεσουάρ ή/και των προσαρτημάτων (π.χ. κουμπιά, περιστρεφόμενα μέρη, καλώδια, Εγχειρίδιο Χρήστη, κτλ.), και
- (ι) Τυχόν παραμόρφωση, αποχρωματισμό, διαστρέβλωση ή/και σκουριά του εξωτερικού μέρους του προϊόντος, περιλαμβανομένης της επιφάνειας της οθόνης LCD.

Ο Αρχικός Αγοραστής για να δικαιούται υπηρεσίες επισκευής σύμφωνα με την Εγγύηση, θα πρέπει να παραδώσει το Προϊόν, με πληρωμένα τα μεταφορικά έξοδα, στην αρχική του συσκευασία ή σε άλλη επαρκή συσκευασία με ισότιμο βαθμό προστασίας, αναλαμβάνοντας τον κίνδυνο βλάβης ή/και απώλειας κατά τη μεταφορά, στον τοπικό Διανομέα. Ο Αρχικός Αγοραστής όταν ζητά υπηρεσίες επισκευής σύμφωνα με την Εγγύηση, θα πρέπει να προσκομίζει την απόδειξη αγοράς του Προϊόντος και την ημερομηνία της αγοράς.

Η Περίοδος Εγγύησης για οποιοδήποτε αντικατεστημένο ή/και επισκευασμένο προϊόν σύμφωνα με την παρούσα Εγγύηση λήγει στο τέλος της αρχικής Περιόδου Εγγύησης.

Η EIZO Ή ΟΙ ΔΙΑΝΟΜΕΙΣ ΔΕΝ ΕΥΘΥΝΟΝΤΑΙ ΓΙΑ ΟΠΟΙΟΔΗΠΟΤΕ ΒΛΑΒΗ Ή ΑΠΩΛΕΙΑ ΔΕΔΟΜΕΝΩΝ Ή ΑΛΛΩΝ ΠΛΗΡΟΦΟΡΙΩΝ ΠΟΥ ΑΠΟΘΗΚΕΥΟΝΤΑΙ ΣΕ ΟΠΟΙΟΔΗΠΟΤΕ ΜΕΣΟ Ή ΟΠΟΙΟΔΗΠΟΤΕ ΑΛΛΟ ΜΕΡΟΣ ΣΕ ΟΠΟΙΟΔΗΠΟΤΕ ΠΡΟΪΟΝ ΠΟΥ ΕΠΙΣΤΡΕΦΕΤΑΙ ΣΤΗΝ EIZO Ή ΣΕ ΔΙΑΝΟΜΕΑ ΓΙΑ ΕΠΙΣΚΕΥΗ.

Η EIZO ΚΑΙ ΟΙ ΔΙΑΝΟΜΕΙΣ ΔΕΝ ΠΑΡΕΧΟΥΝ ΚΑΜΙΑ ΠΕΡΑΙΤΕΡΩ ΕΓΓΥΗΣΗ, ΡΗΤΗ Ή ΣΥΝΕΠΑΓΟΜΕΝΗ, ΟΣΟΝ ΑΦΟΡΑ ΤΟ ΠΡΟΪΟΝ ΚΑΙ ΤΗΝ ΠΟΙΟΤΗΤΑ, ΤΗΝ ΑΠΟΔΟΣΗ, ΤΗΝ ΕΜΠΟΡΕΥΣΙΜΟΤΗΤΑ Ή ΤΗΝ ΚΑΤΑΛΛΗΛΟΤΗΤΑ ΤΟΥ ΓΙΑ ΟΠΟΙΟΔΗΠΟΤΕ ΣΥΓΚΕΚΡΙΜΕΝΗ ΧΡΗΣΗ. ΣΕ ΚΑΜΙΑ ΠΕΡΙΠΤΩΣΗ Η EIZO Ή ΟΙ ΔΙΑΝΟΜΕΙΣ ΔΕΝ ΘΑ ΕΥΘΥΝΟΝΤΑΙ ΓΙΑ ΚΑΜΙΑ ΑΠΟΛΥΤΩΣ ΤΥΧΑΙΑ, ΕΜΜΕΣΗ, ΕΙΔΙΚΗ, ΣΥΝΕΠΑΓΟΜΕΝΗ Ή ΑΛΛΗ ΒΛΑΒΗ (ΠΕΡΙΛΑΜΒΑΝΟΜΕΝΩΝ, ΜΕΤΑΞΥ ΑΛΛΩΝ, ΒΛΑΒΩΝ Ή ΑΠΩΛΕΙΑΣ ΚΕΡΔΩΝ, ΔΙΑΚΟΠΗΣ ΕΠΙΧΕΙΡΗΜΑΤΙΚΩΝ ΔΡΑΣΤΗΡΙΟΤΗΤΩΝ, ΑΠΩΛΕΙΑΣ ΕΠΙΧΕΙΡΗΜΑΤΙΚΩΝ ΠΛΗΡΟΦΟΡΙΩΝ Ή ΤΥΧΟΝ ΑΛΛΗΣ ΧΡΗΜΑΤΙΚΗΣ ΑΠΩΛΕΙΑΣ) ΠΟΥ ΠΡΟΚΥΠΤΕΙ ΑΠΟ ΤΗ ΧΡΗΣΗ Ή ΤΗΝ ΑΝΙΚΑΝΟΤΗΤΑ ΧΡΗΣΗΣ ΤΟΥ ΠΡΟΪΟΝΤΟΣ Ή ΤΥΧΟΝ ΑΛΛΗΣ ΣΥΝΔΕΣΗΣ ΜΕ ΤΟ ΠΡΟΪΟΝ, ΕΙΤΕ ΒΑΣΙΖΕΤΑΙ ΣΕ ΣΥΜΒΟΛΑΙΟ, ΒΛΑΒΗ, ΑΜΕΛΕΙΑ, ΑΥΣΤΗΡΗ ΕΥΘΥΝΗ Ή ΕΙΔΑΛΛΩΣ, ΑΚΟΜΗ ΚΙ ΕΑΝ Η EIZO Ή ΟΙ ΔΙΑΝΟΜΕΙΣ ΕΝΗΜΕΡΩΘΟΥΝ ΓΙΑ ΤΗΝ ΠΙΘΑΝΟΤΗΤΑ ΤΕΤΟΙΩΝ ΖΗΜΙΩΝ. Η ΕΞΑΙΡΕΣΗ ΑΥΤΗ ΠΕΡΙΛΑΜΒΑΝΕΙ ΕΠΙΣΗΣ ΟΠΟΙΟΔΗΠΟΤΕ ΕΥΘΥΝΗ ΕΝΔΕΧΕΤΑΙ ΝΑ ΠΡΟΚΥΨΕΙ ΑΠΟ ΑΞΙΩΣΕΙΣ ΤΡΙΤΟΥ ΜΕΡΟΥΣ ΚΑΤΑ ΤΟΥ ΑΡΧΙΚΟΥ ΑΓΟΡΑΣΤΗ. Η ΟΥΣΙΑ ΤΟΥ ΟΡΟΥ ΑΥΤΟΥ ΕΙΝΑΙ ΝΑ ΠΕΡΙΟΡΙΣΕΙ ΤΗΝ ΠΙΘΑΝΗ ΕΥΘΥΝΗ ΤΗΣ EIZO ΚΑΙ ΤΩΝ ΔΙΑΝΟΜΕΩΝ ΠΟΥ ΠΡΟΚΥΠΤΕΙ ΑΠΟ ΤΗΝ ΠΑΡΟΥΣΑ ΕΓΓΥΗΣΗ Ή/ΚΑΙ ΤΙΣ ΠΩΛΗΣΕΙΣ.



## ОГРАНИЧЕННАЯ ГАРАНТИЯ

EIZO Corporation (называемая в дальнейшем “EIZO”) и авторизованные EIZO дистрибуторы (называемые в дальнейшем “Дистрибуторы”) гарантируют, в соответствии с условиями и пунктами этой ограниченной гарантии (называемой в дальнейшем “Гарантия”), первичному покупателю (называемому в дальнейшем “Первоначальный покупатель”), который приобрел у EIZO или Дистрибуторов продукт, указанный в этом документе (называемый в дальнейшем “Продукт”), что EIZO или Дистрибуторы на свое усмотрение либо бесплатно отремонтируют, либо бесплатно заменят Продукт, если Первоначальный покупатель признает в пределах Гарантийного срока (определенного ниже), что Продукт неисправен или он поврежден процессе нормального использования продукта в соответствии с описанием в инструкции по эксплуатации, прилагаемой к Продукту (называемой в дальнейшем “Руководство пользователя”).

Гарантийный период ограничен сроком три (3) года от даты приобретения Продукта (называемый в дальнейшем “Гарантийный период”). EIZO и Дистрибуторы не несут никакой ответственности и не берут обязательство относительно Продукта по отношению к Первоначальному покупателю или по отношению к любым третьим сторонам, кроме обязательств, оговоренных в этой Гарантии.

Компания EIZO и ее дистрибуторы прекращают хранить детали продукта в продаже или на складе по прошествии десяти (10) лет с момента снятия детали с производства. В случае ремонта монитора EIZO и Дистрибуторы будут использовать запчасти, которые соответствуют нашим стандартам QC (контроль качества).

Гарантия действительна только в странах или регионах, где расположены Дистрибуторы. Гарантия не ограничивает никакие законные права Первоначального покупателя.

Несмотря на другие условия этой Гарантии EIZO и Дистрибуторы не несут никаких обязательств согласно этой Гарантии в любом из перечисленных ниже случаев:

- (а) Любые дефекты Продукта, вызванные повреждениями при перевозке, модификацией, изменением, неправильным обращением, неправильным использованием, авариями, неправильной установкой, стихийными бедствиями, неправильным уходом и/или неправильным ремонтом третьей стороной, отличной от EIZO или Дистрибуторов;
- (б) Любые несовместимости Продукта из-за технических усовершенствований и/или изменения технических норм;
- (в) Любое повреждение датчика;
- (г) Любые ухудшения работы дисплея, вызванные изнашиванием невосстановимых частей, таких как панель ЖКД и/или подсветка и т.д. (например, изменение в яркости, изменение в равномерности яркости, изменение в цветности, изменение в равномерности цветности, изменение в пикселях, включая выгоревшие пиксели и т.д.);
- (д) Любые дефекты Продукта, возникшие вследствие его размещения в месте, где Продукт может быть подвержен сильной вибрации или ударам;
- (е) Любые дефекты Продукта, вызванные внешним оборудованием;
- (ж) Любые дефекты Продукта, при которых оригинальный серийный номер был изменен или удален;
- (з) Любые дефекты Продукта, вызванные протеканием батарейки;
- (и) Любые естественные ухудшения продукта, в частности, вызванные износом расходных частей, принадлежностей и/или приспособлений (например, кнопок, вращающихся частей, кабелей, Руководства пользователя и т.д.); и
- (j) Любые деформации, изменения цвета, коробления и/или коррозия внешней поверхности продукта, включая поверхность панели ЖКД.

Чтобы получить техническое обслуживание в рамках Гарантии, Первоначальный покупатель должен доставить Продукт местному Дистрибутору, оплатив перевозку, в его оригинальной упаковке или в другой соответствующей упаковке, обеспечивающей равноценную степень защиты, принимая во внимание риск повреждения и/или утери при транспортировке. При запросе технического обслуживания в рамках Гарантии Первоначальный покупатель должен предоставить свидетельство покупки продукта и даты покупки.

Гарантийный период для любого замененного и/или отремонтированного продукта в рамках Гарантии истекает в конце завершения срока действия оригинального Гарантийного периода.

**EIZO ИЛИ ДИСТРИБУТОРЫ НЕ НЕСУТ ОТВЕТСТВЕННОСТИ ЗА ЛЮБЫЕ ПОВРЕЖДЕНИЯ ИЛИ УТЕРЮ ДАННЫХ ИЛИ ДРУГОЙ ИНФОРМАЦИИ, ХРАНЯЩИХСЯ НА КАКИХ-ЛИБО НОСИТЕЛЯХ ИНФОРМАЦИИ ИЛИ НА ЛЮБЫХ ДРУГИХ ЧАСТЯХ ПРОДУКТА, КОТОРЫЙ ВОЗВРАЩЕН EIZO ИЛИ ДИСТРИБУТОРАМ ДЛЯ РЕМОНТА.**

EIZO и ДИСТРИБУТОРЫ НЕ ДАЮТ НИКАКОЙ ДАЛЬНЕЙШЕЙ ГАРАНТИИ, ВЫРАЖЕННОЙ ИЛИ ПОДРАЗУМЕВАЕМОЙ, ОТНОСИТЕЛЬНО ПРОДУКТА И ЕГО КАЧЕСТВА, ТЕХНИЧЕСКИХ ХАРАКТЕРИСТИК, ТОВАРНОСТИ ИЛИ СООТВЕТСТВИЯ ДЛЯ КАКОГО-ЛИБО ОПРЕДЕЛЕННОГО ИСПОЛЬЗОВАНИЯ. НИ ПРИ КАКИХ УСЛОВИЯХ EIZO ИЛИ ДИСТРИБУТОРЫ НЕ НЕСУТ ОТВЕТСТВЕННОСТИ ЗА ЛЮБОЙ СЛУЧАЙНЫЙ, КОСВЕННЫЙ, СПЕЦИАЛЬНЫЙ, ПОБОЧНЫЙ ИЛИ ИНОЙ УЩЕРБ (ВКЛЮЧАЯ, БЕЗ ОГРАНИЧЕНИЙ, УЩЕРБ ИЗ-ЗА НЕПОЛУЧЕННОЙ ПРИБЫЛИ, ПРЕРЫВАНИЯ БИЗНЕСА, ПОТЕРИ КОММЕРЧЕСКОЙ ИНФОРМАЦИИ ИЛИ ЛЮБЫЕ ДРУГИЕ ФИНАНСОВЫЕ ПОТЕРИ), ВОЗНИКШИЙ ИЗ-ЗА ИСПОЛЬЗОВАНИЯ ИЛИ НЕВОЗМОЖНОСТИ ИСПОЛЬЗОВАТЬ ПРОДУКТ ИЛИ В ЛЮБОЙ ДРУГОЙ СВЯЗИ С ПРОДУКТОМ, ЛИБО ОСНОВАННЫЙ НА КОНТРАКТНЫХ ОТНОШЕНИЯХ, ГРАЖДАНСКИХ ПРАВОНАРУШЕНИЯХ, НЕБРЕЖНОСТИ, ПРИЧИНЕНИЯ УЩЕРБА ТРЕТЬЕЙ СТОРОНЕ ИЛИ ЧЕМ-ЛИБО ЕЩЕ, ДАЖЕ ЕСЛИ EIZO ИЛИ ДИСТРИБУТОРЫ БЫЛИ УВЕДОМЛЕННЫ О ВОЗМОЖНОСТИ ТАКОГО УЩЕРБА. ЭТО ИСКЛЮЧЕНИЕ ТАКЖЕ ВКЛЮЧАЕТ ЛЮБЫЕ ОБЯЗАТЕЛЬСТВА, КОТОРЫЕ МОГУТ ВОЗНИКНУТЬ В РЕЗУЛЬТАТЕ ТРЕБОВАНИЙ ТРЕТЬЕЙ СТОРОНЫ В ОТНОШЕНИИ ПЕРВОНАЧАЛЬНОГО ПОКУПАТЕЛЯ. СУЩЕСТВОМ ЭТОГО ПОЛОЖЕНИЯ ЯВЛЯЕТСЯ ОГРАНИЧЕНИЕ ПОТЕНЦИАЛЬНОЙ ОТВЕТСТВЕННОСТИ EIZO И ДИСТРИБУТОРОВ, ВОЗНИКАЮЩЕЙ ИЗ-ЗА ЭТОЙ ОГРАНИЧЕННОЙ ГАРАНТИИ И/ЛИ ПРОДАЖ.

## 有限责任保证书

EIZO Corporation (以下简称“**EIZO**”)和 EIZO 授权的经销商 (以下简称“**经销商**”), 接受并依照本有限责任保证书 (以下简称“**保证书**”)之条款, 向从 EIZO 和经销商购买本文中规定产品 (以下简称“**产品**”)的原买方 (以下称“**原买方**”)提供保证: 在保证期内 (规定如下), 如果原买方发现按本产品所附使用说明书 (以下简称“**用户手册**”)所述方式正常使用本产品过程中, 本产品出现故障或损坏, EIZO 和经销商根据其独立的判断免费修理或更换该产品。

本保证期限定为本产品自购买本产品之日起的三 (3) 年 (以下简称“**保证期限**”)。EIZO 和经销商将不向原买方或任何第三方承担本保证书所规定之外的与本产品有关任何责任或义务。

EIZO 和经销商将不再保留或储存任何停产超过十 (10) 年的产品的零部件。维修显示器时, EIZO 与经销商将使用符合我方质量控制标准的替换零件。

本保证书仅对于设有经销商的国家或地区有效。本保证书并不限定原买方的任何法律权利。

无论本保证书的任何其他条款如何规定, 对于任何下列情况之一, EIZO 和经销商将不承担本保证书规定责任:

- (a) 由于运输损害、改装、改动、滥用、误用、意外事故、错误安装、灾害、维护不善和 / 或由除 EIZO 和经销商以外的第三方进行不适当的修理造成本产品的任何故障。
- (b) 由于可能发生的技术变更和 / 或调整造成本产品的任何不兼容性。
- (c) 传感器的任何劣化。
- (d) 由于诸如液晶显示屏 (LCD) 和 / 或背灯等消耗品部件的老化造成的任何显示性能低劣 (如亮度变化、亮度均一性变化、色彩变化、色彩均一性变化、如烧伤像素等像素缺陷)。
- (e) 将产品放置在可能受强烈振动或冲击影响的位置, 可能会导致产品出现缺陷。
- (f) 因外部设备造成本产品的任何故障。
- (g) 因本产品的原序号被改变或消除造成本产品的任何故障。
- (h) 因电池液体泄漏造成本产品的任何故障。
- (i) 本产品的任何正常老化, 尤其是消耗品、附件和 / 或附加装置 (如按钮、旋转部件、电缆、用户手册等)、以及
- (j) 本产品表面包括液晶显示屏 (LCD) 表面的任何变形、变色、翘曲和 / 或生锈。

为了获得本保证书规定的服务, 原买方必须使用原包装或其他具有同等保护程度的适当包装将本产品运送到当地的经销商, 并且预付运费, 承担运输中的损坏和 / 或损失的风险。要求提供本保证书规定的服务时, 原买方必须提交购买本产品和标明此购买日期的证明。

按本保证书规定进行了更换和 / 或修理的任何产品的保证期限, 将在原保证期限结束时终止。

在返回给 EIZO 和经销商进行修理后, 任何产品的任何媒体或任何部件中储存的数据或其他信息发生任何损坏或损失, 对此 EIZO 和经销商将不承担责任。

对于本产品及其质量、性能、可销售性以及对于特殊用途的适合性, EIZO 和经销商不提供其他任何明示或暗示的保证。因使用本产品或无法使用本产品或因与本产品有任何关系 (无论是否根据合同) 而造成: 任何附带的、间接的、特殊的、随之发生的或其他的损害 (包括但不限于: 利润损失、业务中断、业务信息丢失或其他任何金钱损失) 以及侵权行为、过失、严格赔偿责任或其他责任, 即使已经向 EIZO 和经销商提出了发生这些损害的可能性, 对此 EIZO 和经销商概不承担责任。本免责条款还包括因第三方向原买方提出索赔而可能发生的任何责任。本条款的本质是限定由于本有限责任保证书和 / 或销售本产品所发生的 EIZO 和经销商的潜在责任。

## 제한 보증

EIZO Corporation( 이후 “EIZO” 라고 함) 및 EIZO 가 승인한 유통업체 ( 이후 “유통업체” 라고 함) 는 제한 보증 ( 이후 “보증” 이라고 함) 약관에 따라 EIZO 또는 유통업체로부터 이 문서에 지정된 제품 ( 이후 “제품” 이라고 함) 을 구입한 최초 구매자 ( 이후 “최초 구매자” 라고 함) 에게 EIZO 및 유통업체는 고유 권한에 의거하여 최초 구매자가 보증 기간 ( 아래 정의) 내에 제품에 부착된 사용 설명서 ( 이후 “사용 설명서” 라고 함) 의 설명에 따라 제품을 정상적으로 사용하는 과정에서 제품이 고장났거나 손상된 것을 알게된 경우 무료로 교체 또는 수리해야 합니다 .

이 보증 기간은 제품 구입일로부터 3 년입니다 ( 이후 “보증 기간” 이라고 함) . EIZO 및 유통업체는 본 보증 하에 제공된 내용을 제외하고 최초 구매자 또는 제 3 자와 관련된 제품에 대해 어떠한 책임도 없습니다 .

EIZO 및 총판은 제품별 부품의 생산 중단일로부터 10 년이 경과하면 해당 제품의 모든 부품을 보유 또는 보관하지 않습니다 . 모니터 수리 시 EIZO 및 유통업체는 당사의 QC 표준을 준수하는 재생 부품을 사용합니다 .

보증은 유통업체가 위치한 국가 또는 지역에서만 유효합니다 . 보증은 최초 구매자의 법적 권한을 제한하지 않습니다 .

본 보증의 다른 규정에도 불구하고 , EIZO 및 유통업체는 아래 규정된 경우에 대해서는 본 보증 하에서 보증 의무가 없습니다 .

- (a) EIZO 및 유통업체 이외 제 3 자에 의한 화물 운송 피해 , 개조 , 변경 , 남용 , 오용 , 사고 , 부적절한 설치 , 재난 , 잘못된 유지보수 및 / 또는 부적절한 수리로 인해 발생하는 제품 결함 ;
- (b) 가능한 기술 혁신 및 / 또는 규정으로 인한 제품의 비호환성 ;
- (c) 센서 품질 불량 ;
- (d) LCD 패널 및 / 또는 백라이트 등과 같이 확장 가능 부품의 품질 불량으로 인한 디스플레이 성능 저하 . ( 예 : 밝기 변화 , 밝기 일관성 변화 , 컬러 변화 , 컬러 일관성 변화 , 픽셀 번짐 등을 포함한 픽셀 결함 .) ;
- (e) 강한 진동 또는 충격에 의해 영향 받을 수 있는 장소에 배치함으로써 발생하는 제품 결함 ;
- (f) 외부 장비에 의해 발생하는 제품 결함 ;
- (g) 최초 일련 번호를 변경하거나 제거한 제품의 결함 ;
- (h) 배터리에 누출로 인해 발생하는 제품 결함 ;
- (i) 특히 소모품 , 액세서리 및 / 또는 부착장치 ( 예 : 버튼 , 회전 부품 , 케이블 , 사용 설명서 등 ) 를 포함하여 제품의 정상적인 성능 저하 ; 및
- (j) LCD 패널 표면을 포함하여 제품 외관의 변형 , 변색 , 흠 및 / 또는 녹 발생 .

보증 하에서 서비스를 받으려면 최초 구매자가 운송 중 손상 및 / 또는 손실 위험을 고려하여 최초 포장 또는 동등한 보호 수준을 제공하는 기타 적절한 포장에 제품을 포함하여 선불 운임으로 가까운 유통업체에 보내야 합니다 . 최초 구매자는 보증 하에서 서비스 요청 시 제품 구입 및 이러한 구입 날짜 증명서를 제출해야 합니다 .

본 보증 하의 어떠한 교체 및 / 또는 수리 제품에 대한 보증 기간도 최초 보증 기간 종료 시 만료됩니다 .

EIZO 또는 유통업체는 수리를 위해 EIZO 또는 유통업체에 반환된 미디어 또는 제품의 부품에 보관된 데이터 또는 기타 정보의 손상 또는 분실에 대해 책임을 지지 않습니다 .

EIZO 및 유통업체는 특정 용도에 대한 제품 및 품질 , 성능 , 상품성 또는 적합성과 관련하여 명시적 또는 암묵적으로 추가 보증을 하지 않습니다 . 어떠한 경우에도 EIZO 또는 유통업체는 제품 또는 제품과 관련하여 사용으로부터 발생하거나 사용 불능으로 인해 발생하는 실수 , 간접적 , 특별한 , 결과적 또는 기타 어떠한 손상 ( 수익 손실 피해 , 사업 중단 , 사업 정보 손실 또는 기타 금전상의 손실 포함 , 이에 국한되지 않음 ) 에 대해 , 계약 , 불법 행위 , 무시 , 엄격한 법적 책임 또는 EIZO 또는 유통업체가 이러한 피해 가능성에 대해 조연한 경우에도 책임을 지지 않습니다 . 또한 이 예외 규정에는 최초 구매자에 대한 제 3 자 클레임으로부터 발생할 수 있는 어떠한 법적 책임도 포함됩니다 . 본 규정의 핵심은 이 제한 보증 및 / 또는 판매로 인해 발생하는 EIZO 및 유통업체의 잠재적 법적 책임을 제한하는 것입니다 .

# Recycling Information

---

## Recycling Information

This product, when disposed of, is supposed to be collected and recycled according to your country's legislation to reduce environmental burden. When you dispose of this product, please contact a distributor or an affiliate in your country.

The contact addressees are listed on the EIZO website below.

<http://www.eizoglobal.com>

For recycling information for customers in Switzerland, please refer to the following website.

<http://www.swico.ch>

## Informationen zum Thema Recycling

Dieses Produkt muss gemäß den Vorschriften Ihres Landes zur Entlastung der Umwelt recyclet werden. Wenden Sie sich bei der Entsorgung dieses Produkts an einen Verteiler oder eine Tochtergesellschaft in Ihrem Land.

Die Adressen zur Kontaktaufnahme sind auf der unten angegebenen Website von EIZO aufgeführt.

<http://www.eizoglobal.com>

Kunden in der Schweiz entnehmen Informationen zum Recycling der folgenden Website:

<http://www.swico.ch>

## Informations sur le recyclage

Ce produit doit être jeté aux points de collecte prévus à cet effet et recyclé conformément à la législation de votre pays, afin de réduire l'impact sur l'environnement. Lorsque vous jetez ce produit, veuillez contacter un distributeur ou une société affiliée de votre pays.

Les adresses des distributeurs sont répertoriées sur le site Web EIZO ci-dessous.

<http://www.eizoglobal.com>

Pour les clients en Suisse, veuillez consulter le site Web suivant afin d'obtenir des informations sur le recyclage.

<http://www.swico.ch>

## Información sobre reciclaje

Este producto debe desecharse y reciclarse según la legislación del país para reducir el impacto medioambiental. Cuando desee deshacerse de este producto, póngase en contacto con un distribuidor o una filial de su país.

Encontrará las direcciones de contacto en el sitio web de EIZO que se indica a continuación.

<http://www.eizoglobal.com>

## Informazioni sul riciclaggio

Per lo smaltimento e il riciclaggio del presente prodotto, attenersi alle normative vigenti nel proprio paese per ridurre l'impatto ambientale. Per lo smaltimento, rivolgersi ad un distributore o un affiliato presenti nel proprio paese.

Gli indirizzi sono elencati nel sito Web EIZO riportato di seguito.

<http://www.eizoglobal.com>

Per informazioni sul riciclaggio per i clienti in Svizzera, consultare il sito Web riportato di seguito.

<http://www.swico.ch>

## Återvinningsinformation

När denna produkt kasseras ska den hanteras och återvinnas enligt landets föreskrifter för att reducera miljöpåverkan. När du kasserar produkten ska du kontakta en distributör eller representant i ditt land.

Kontaktadresserna listas på EIZO-webbplatsen nedan.

<http://www.eizoglobal.com>



## Πληροφορίες ανακύκλωσης

Το προϊόν αυτό, όταν απορρίπτεται, πρέπει να συλλέγεται και να ανακυκλώνεται σύμφωνα με τη νομοθεσία της χώρας σας έτσι ώστε να μην επιβαρύνει το περιβάλλον. Για να απορρίψετε το προϊόν, επικοινωνήστε με έναν αντιπρόσωπο ή μια θυγατρική εταιρεία στη χώρα σας.

Οι διευθύνσεις επικοινωνίας αναγράφονται στην τοποθεσία web της EIZO παρακάτω.  
<http://www.eizoglobal.com>

## Сведения по утилизации

По истечении срока службы данного продукта его следует принести на сборный пункт и утилизировать в соответствии с действующими предписаниями в вашей стране, чтобы уменьшить вредное воздействие на окружающую среду. Прежде чем выбросить данный продукт, обратитесь к дистрибьютору или в местное представительство компании в вашей стране.

Контактные адреса можно найти на веб-узле EIZO.

<http://www.eizoglobal.com>

## Informatie over recycling

Wanneer u dit product wilt weggooien, moet het uit milieu-overwegingen worden verzameld en gerecycled volgens de betreffende wetgeving van uw land. Wanneer u dit product wilt weggooien, moet u contact opnemen met een distributeur of een partner in uw land.

De contactadressen worden vermeld op de volgende EIZO-website.

<http://www.eizoglobal.com>

## Informação sobre reciclagem

Este produto, quando o deitar fora, deve ser recolhido e reciclado de acordo com a legislação do seu país para reduzir a poluição. Quando deitar fora este produto, contacte um distribuidor ou uma filial no seu país.

Os endereços de contacto estão listados no website do EIZO, abaixo.

<http://www.eizoglobal.com>

## Oplysninger om genbrug

Denne produkt forventes ved bortskaffelse at blive indsamlet og genbrugt i overensstemmelse med lovgivningen i dit land for at reducere belastningen af miljøet. Når du bortskaffer denne produkt, skal du kontakte en distributør eller et tilknyttet selskab i dit land.

Adresserne på kontaktpersonerne er angivet på EIZO's websted nedenfor.

<http://www.eizoglobal.com>

## Kierrätystä koskevia tietoja

Tuote tulee hävittää kierrättämällä maan lainsäädännön mukaisesti ympäristön kuormittumisen vähentämiseksi. Kun hävität tuotteen, ota yhteyttä jälleenmyyjään tai tytäryhtiöön maassasi.

Yhteystiedot löytyvät EIZOn Internet-sivustolta.

<http://www.eizoglobal.com>

## Wykorzystanie surowców wtórnych

Ten produkt po zużyciu powinien być zbierany i przetwarzany zgodnie z krajowymi przepisami dotyczącymi ochrony środowiska. Wyrzucając ten produkt, należy skontaktować się z lokalnym dystrybutorem lub partnerem. Adresy kontaktowe można znaleźć we wskazanej poniżej witrynie internetowej firmy EIZO.

<http://www.eizoglobal.com>

## Informace o recyklaci

Při likvidaci produktu musí být produkt vyzvednut a recyklován podle zákonů příslušné země, aby nedocházelo k zatěžování životního prostředí. Zbavujete-li se produktu, kontaktujte distributora nebo pobočku ve své zemi. Kontaktní adresy jsou uvedeny na následující webové stránce společnosti EIZO.  
<http://www.eizoglobal.com>

## Ringlussevõtu alane teave

Keskkonnakoormuse vähendamiseks tuleks kasutatud tooted kokku koguda ja võtta ringlusse vastavalt teie riigi seadustele. Kui kõrvaldate käesoleva toote, võtke palun ühendust turustaja või filiaaliga oma riigis. Kontaktisikud on toodud EIZO veebilehel järgmisel aadressil:  
<http://www.eizoglobal.com>

## Újrahasznosítási információ

Jelen terméket, amikor eldobjuk, az illető ország törvényei alapján kell összegyűjteni és újrahasznosítani, hogy csökkentsük a környezet terhelését. Amikor ezt a terméket eldobja, kérjük lépjen kapcsolatba egy országon belüli forgalmazóval vagy társvállalkozással.  
A kapcsolat címei az EIZO alábbi weboldalán találhatók felsorolva:  
<http://www.eizoglobal.com>

## Podatki o recikliranju

Ob koncu uporabe odslužen izdelek izročite na zbirno mesto za recikliranje v skladu z okoljevarstveno zakonodajo vaše države. Prosimo, da se pri odstranjevanju izdelka obrnete na lokalnega distributerja ali podružnico.  
Kontaktne naslovi so objavljeni na spodaj navedenih spletnih straneh EIZO:  
<http://www.eizoglobal.com>

## Informácie o recyklácii

Pri likvidácii musí byť tento výrobok recyklovaný v súlade s legislatívou vašej krajiny, aby sa znížilo zaťaženie životného prostredia. Keď sa chcete zbaviť tohto výrobku, kontaktujte prosím distribútora alebo pobočku vo vašej krajine.  
Zoznam kontaktných adries je uvedený na nasledovnej webovej stránke firmy EIZO:  
<http://www.eizoglobal.com>

## Pārstrādes informācija

Utilizējot šo produktu, tā savākšana un pārstrāde veicama atbilstoši jūsu valsts likumdošanas prasībām attiecībā uz slodzes uz vidi samazināšanu. Lai veiktu šī produkta utilizāciju, sazinieties ar izplatītāju vai pārstāvniecību jūsu valstī.  
Kontaktadrese ir norādītas zemāk minētajā EIZO tīmekļa vietnē.  
<http://www.eizoglobal.com>

## Informacija apie gražinamąjį perdirbimą

Šalinant (išmetant) šiuos gaminius juos reikia surinkti ir perdirbti gražinamuoju būdu pagal jūsų šalies teisės aktus, siekiant sumažinti aplinkos teršimą. Kai reikia išmesti šį gaminį, kreipkitės į jūsų šalyje veikiančią gaminių pardavimo atstovybę arba jos filiaalą.  
Kontaktiniai adresatai nurodyti EIZO interneto svetainėje.  
<http://www.eizoglobal.com>

## Информация относно рециклиране

При изхвърлянето на този продукт се предлага събирането и рециклирането му съобразно законите на вашата страна за да се намали замърсяването на околната среда. Когато искате да се освободите от този продукт, моля свържете се с търговския му представител или със съответните органи отговарящи за това във вашата страна.

Данните за връзка с нас са описани на следния Интернет сайт на EIZO:  
<http://www.eizoglobal.com>

## Informație referitoare la reciclare

Acest produs, când debarasat, trebuie colectat și reciclat conform legislației țării respective ca să reducem sarcina mediului. Când se debarasează de acest produs, vă rugăm să contactați un distribuitor sau un afiliat al țării respective.

Adresele de contact le găsiți pe pagina de web al EIZO:  
<http://www.eizoglobal.com>

## معلومات عن إعادة التدوير

عند التخلص من هذا المنتج، من الضروري تجميعه وإعادة تدويره وفقاً للقوانين المتبعة في بلدك لتقليل العبء المسلط على البيئة. عندما تتخلص من هذا المنتج، يرجى الاتصال بموزع أو طرف متنسب إليه في بلدك. عناوين الاتصال مدرجة في موقع ايزو EIZO ادناه على شبكة الانترنت.

<http://www.eizoglobal.com>

## Geri Dönüşüm Bilgisi

Bu ürünün, atılacağı zaman, ülkenizin çevre kirliliğinin azaltılması konusundaki mevzuatına göre toplanması ve yeniden değerlendirilmesi gerekmektedir. Ürünü atacağınız zaman lütfen ülkenizdeki bir distribütör veya ilgili kuruluşla temasa geçiniz.

İrtibat adresleri aşağıdaki EIZO web sitesinde verilmiştir.  
<http://www.eizoglobal.com>

