



IR1101 Industrial Integrated Services Router Hardware Installation Guide

First Published: 2018-07-04

Last Modified: 2020-07-06

Americas Headquarters

Cisco Systems, Inc.
170 West Tasman Drive
San Jose, CA 95134-1706
USA
<http://www.cisco.com>
Tel: 408 526-4000
800 553-NETS (6387)
Fax: 408 527-0883



CONTENTS

CHAPTER 1

Preface 1

Preface 1

Objective 1

Audience 1

Conventions 1

Safety Warnings 2

Related Documentation 8

Searching Cisco Documents 8

CHAPTER 2

Product Overview 9

Product Overview 9

General Description 9

SKU Information 10

Cisco IR1101 Series Platform Features 11

Cisco IR1101 Base Router 11

Cisco IRM-1100-SPMI Expansion Module 13

Cisco IR-1100-SP Expansion Module 17

Cisco Pluggable Module 17

mSATA Module 19

Front Panel Icons and LEDs 20

Memory 22

Reset Button 22

Supported Cisco Antennas and Antenna Accessories 22

Modem Support 22

Power Supply 25

RJ45 Ports 26

SFP Module 26

CHAPTER 3**Installing the Router 29**

Installing the Router 29

Equipment, Tools, and Connections 30

Items Shipped with your Router 30

Additional Items 30

Ethernet Devices 30

Installing the Router 30

Warnings 30

Mounting on a Wall, Table, or Other Flat Surface 31

Installing a DIN Rail 34

Mounting the DIN Rail Bracket on the Router 35

Attaching the Bracket onto the DIN Rail 36

Installing the Router Ground Connection 38

Pluggable Module 39

CHAPTER 4**Antenna Selection and Installation 45**

Antenna Selection and Installation 45

Antenna Installation Best Practices 45

Supported Antennas for the IR1101 47

Cellular 2G/3G/4G Antennas 47

GPS Antennas 48

Supported RF Cables for the IR1101 49

Cellular Antenna Extension Bases 51

Accessories 51

CHAPTER 5**Installing the IRM-1100 Expansion Module 53**

Installing the IRM-1100 Expansion Module 53

Items Shipped with your Expansion Module 53

Installing the Expansion Module 53

Mounting the IR1101 Router with the IRM-1100 Expansion Module Attached 56

Mounting the Device Using Mounting Brackets 56

Installing a DIN Rail 60

Mounting the DIN Rail Bracket on the Device	61
Attaching the Bracket Onto the DIN Rail	61
Pluggable Module	63
Digital I/O Connections	63
Installing the mSATA SSD	65
mSATA Installation Instructions	65

CHAPTER 6**Connecting the Router 67**

Connecting the Router	67
Preparing to Connect the Router	67
Preventing Damage to the Router	67
Connecting a PC, Server, or Workstation	67
Connecting a PC to the Console Port	68
Connecting to DC Power	68
Plugs and Pin-Outs	69
Wiring the DC Power	69
Serial Port Cable	71
DB9 Adapter Side	72
RJ-45 Adapter Side	73
Verifying Connections	78

CHAPTER 7**Technical Specifications 79**

Technical Specifications	79
Router Specifications	79
IR1101 Base Unit	79
IRM-1100 Expansion Unit	80
Modem Specifications	81



CHAPTER 1

Preface

This preface describes the objectives, audience, organization, and conventions of this guide and describes related documents that have additional information. The sections are:

- [Preface, on page 1](#)

Preface

This preface describes the objectives, audience, organization, and conventions of this guide and describes related documents that have additional information. The sections are:

Objective

This guide provides an overview and explains how to install and connect the Cisco IR1101.

Audience

This guide is intended for people who have a high level of technical ability, although they may not have experience with Cisco software.

Conventions

This section describes the conventions used in this guide.

NOTE: Means reader take note. Notes contain helpful suggestions or references to additional information and material.

CAUTION: This symbol means reader be careful. In this situation, you might do something that could result in equipment damage or loss of data.

TIP: Means *the following information will help you solve a problem* . The tip information might not be troubleshooting or even an action, but could be useful information.

WARNING: IMPORTANT SAFETY INSTRUCTIONS Means danger. You are in a situation that could cause bodily injury. Before you work on any equipment, be aware of the hazards involved with electrical circuitry and be familiar with standard practices for preventing accidents. Use the statement number provided at the end of each warning to locate its translation in the translated safety warnings that accompanied this device.

Safety Warnings



Caution

If this product will be installed in a hazardous location, read the Getting Started/Product Document of Compliance included in the package.

Warning	<p>This warning symbol means danger. You are in a situation that could cause bodily injury. Before you work on any equipment, be aware of the hazards involved with electrical circuitry and be familiar with standard practices for preventing accidents. Use the statement number provided at the end of each warning to locate its translation in the translated safety warnings that accompanied this device. Statement 1071</p> <p>SAVE THESE INSTRUCTIONS</p>
Waarschuwing	<p>BELANGRIJKE VEILIGHEIDSINSTRUCTIES</p> <p>Dit waarschuwingssymbool betekent gevaar. U verkeert in een situatie die lichamelijk letsel kan veroorzaken. Voordat u aan enige apparatuur gaat werken, dient u zich bewust te zijn van de bij elektrische schakelingen betrokken risico's en dient u op de hoogte te zijn van de standaard praktijken om ongelukken te voorkomen. Gebruik het nummer van de verklaring onderaan de waarschuwing als u een vertaling van de waarschuwing die bij het apparaat wordt geleverd, wilt raadplegen.</p> <p>BEWAAR DEZE INSTRUCTIES</p>
Varoitus	<p>TÄRKEITÄ TURVALLISUUSOHJEITA</p> <p>Tämä varoitusmerkki merkitsee vaaraa. Tilanne voi aiheuttaa ruumiillisia vammoja. Ennen kuin käsittelet laitteistoja, huomioi sähköpiirien käsittelemiseen liittyvät riskit ja tutustu onnettomuuksien yleisiin ehkäisytapoihin. Turvallisuusvaroitusten käännökset löytyvät laitteen mukana toimitettujen käännettyjen turvallisuusvaroitusten joukosta varoitusten lopussa näkyvien lausuntonumeroiden avulla.</p> <p>SÄILYTÄ NÄMÄ OHJEET</p>
Attention	<p>IMPORTANTES INFORMATIONS DE SÉCURITÉ</p> <p>Ce symbole d'avertissement indique un danger. Vous vous trouvez dans une situation pouvant entraîner des blessures ou des dommages corporels. Avant de travailler sur un équipement, soyez conscient des dangers liés aux circuits électriques et familiarisez-vous avec les procédures couramment utilisées pour éviter les accidents. Pour prendre connaissance des traductions des avertissements figurant dans les consignes de sécurité traduites qui accompagnent cet appareil, référez-vous au numéro de l'instruction situé à la fin de chaque avertissement.</p> <p>CONSERVEZ CES INFORMATIONS</p>
Warnung	<p>WICHTIGE SICHERHEITSHINWEISE</p> <p>Dieses Warnsymbol bedeutet Gefahr. Sie befinden sich in einer Situation, die zu Verletzungen führen kann. Machen Sie sich vor der Arbeit mit Geräten mit den Gefahren elektrischer Schaltungen und den üblichen Verfahren zur Vorbeugung vor Unfällen vertraut. Suchen Sie mit der am Ende jeder Warnung angegebenen Anweisungsnummer nach der jeweiligen Übersetzung in den übersetzten Sicherheitshinweisen, die zusammen mit diesem Gerät ausgeliefert wurden.</p> <p>BEWAHREN SIE DIESE HINWEISE GUT AUF.</p>

Avvertenza	<p>IMPORTANTI ISTRUZIONI SULLA SICUREZZA</p> <p>Questo simbolo di avvertenza indica un pericolo. La situazione potrebbe causare infortuni alle persone. Prima di intervenire su qualsiasi apparecchiatura, occorre essere al corrente dei pericoli relativi ai rischi elettrici e conoscere le procedure standard per la prevenzione di incidenti. Utilizzare il numero di istruzioni presente alla fine di ciascuna avvertenza per individuare le traduzioni delle avvertenze riportate in questo documento.</p> <p>CONSERVARE QUESTE ISTRUZIONI</p>
Advarsel	<p>VIKTIGE SIKKERHETSINSTRUKSJONER</p> <p>Dette advarselssymbolet betyr fare. Du er i en situasjon som kan føre til skade på person. Før du begynner å arbeide med noe av utstyret, må du være oppmerksom på farene forbundet med elektriske kretser, og følge de til standardprosedyrer for å forhindre ulykker. Bruk nummeret i slutten av hver advarsel for å finne de tilsvarende oversettelsen i de oversatte sikkerhetsadvarslene som fulgte med denne enheten.</p> <p>TA VARE PÅ DISSE INSTRUKSJONENE</p>
Aviso	<p>INSTRUÇÕES IMPORTANTES DE SEGURANÇA</p> <p>Este símbolo de aviso significa perigo. Você está em uma situação que poderá ser causadora de lesões físicas ou corporais. Antes de iniciar a utilização de qualquer equipamento, tenha conhecimento dos perigos envolvidos no manuseio de circuitos elétricos e familiarize-se com as práticas habituais de prevenção de acidentes. Utilize o número da instrução fornecido ao final de cada aviso para localizar sua tradução nos avisos de segurança traduzidos que acompanham este dispositivo.</p> <p>GUARDE ESTAS INSTRUÇÕES</p>
¡Advertencia!	<p>INSTRUCCIONES IMPORTANTES DE SEGURIDAD</p> <p>Este símbolo de aviso indica peligro. Existe riesgo para su integridad física. Antes de manipular cualquier equipo, considere los riesgos de la corriente eléctrica y familiarícese con los procedimientos estándar de prevención de accidentes. Al final de cada advertencia encontrará el número que le ayudará a encontrar el texto traducido en el apartado de traducciones que acompaña a este dispositivo.</p> <p>GUARDE ESTAS INSTRUCCIONES</p>
Varning!	<p>VIKTIGA SÄKERHETSANVISNINGAR</p> <p>Denna varningssignal signalerar fara. Du befinner dig i en situation som kan leda till personskada. Innan du utför arbete på någon utrustning måste du vara medveten om farorna med elkretsar och känna till de tillämpliga förfaranden för att förebygga olyckor. Använd det nummer som finns i slutet av varje varning för att hitta dess översättning i de översatta säkerhetsvarningar som medföljer denna anordning.</p> <p>SPARA DESSA ANVISNINGAR</p>
Figyelem	<p>FONTOS BIZTONSÁGI ELOÍRÁSOK</p> <p>Ez a figyelmeztető jel veszélyre utal. Sérülésveszélyt rejtő helyzetben van. Mielőtt bármely berendezésen munkát végezte, legyen figyelemmel az elektromos áramkörök okozta kockázatokra, és ismerkedjen meg a szokásos balesetvédelmi eljárásokkal. A kiadványban szereplő figyelmeztetések fordítása a készülékhez mellékelte biztonsági figyelmeztetések között található; a fordítás az egyes figyelmeztetések végén látható szám alapján kereshető meg.</p> <p>ORIZZE MEG EZEKET AZ UTASÍTÁSOKAT!</p>

Предупреждение	<p>ВАЖНЫЕ ИНСТРУКЦИИ ПО СОБЛЮДЕНИЮ ТЕХНИКИ БЕЗОПАСНОСТИ</p> <p>Этот символ предупреждения обозначает опасность. То есть имеет место ситуация, в которой следует опасаться телесных повреждений. Перед эксплуатацией оборудования выясните, каким опасностям может подвергаться пользователь при использовании электрических цепей, и ознакомьтесь с правилами техники безопасности для предотвращения возможных несчастных случаев. Воспользуйтесь номером заявления, приведенным в конце каждого предупреждения, чтобы найти его переведенный вариант в переводе предупреждений по безопасности, прилагаемом к данному устройству.</p> <p>СОХРАНИТЕ ЭТИ ИНСТРУКЦИИ</p>
警告	<p>重要的安全性说明</p> <p>此警告符号代表危险。您正处于可能受到严重伤害的工作环境中。在您使用设备开始工作之前，必须充分认识到触电的危险，并熟练掌握防止事故发生的标准工作程序。请根据每项警告结尾提供的声明号码来找到设备的安全性警告说明的翻译文本。</p> <p>请保存这些安全性说明</p>
警告	<p>安全上の重要な注意事項</p> <p>「危険」の意味です。人身事故を予防するための注意事項が記述されています。装置の取り扱い作業を行うときは、電気回路の危険性に注意し、一般的な事故防止策に留意してください。警告の各国語版の各注意事項の番号を基に、装置に付属の「Translated Safety Warnings」を参照してください。</p> <p>これらの注意事項を保管しておいてください。</p>
주의	<p>중요 안전 지침</p> <p>이 경고 기호는 위험을 나타냅니다. 작업자가 신체 부상을 일으킬 수 있는 위험한 환경에 있습니다. 장비에 작업을 수행하기 전에 전기 회로와 관련된 위험을 숙지하고 표준 작업 관례를 숙지하여 사고를 방지하십시오. 각 경고의 마지막 부분에 있는 경고문 번호를 참조하여 이 장치와 함께 제공되는 번역된 안전 경고문에서 해당 번역문을 찾으십시오.</p> <p>이 지시 사항을 보관하십시오.</p>
Aviso	<p>INSTRUÇÕES IMPORTANTES DE SEGURANÇA</p> <p>Este símbolo de aviso significa perigo. Você se encontra em uma situação em que há risco de lesões corporais. Antes de trabalhar com qualquer equipamento, esteja ciente dos riscos que envolvem os circuitos elétricos e familiarize-se com as práticas padrão de prevenção de acidentes. Use o número da declaração fornecido ao final de cada aviso para localizar sua tradução nos avisos de segurança traduzidos que acompanham o dispositivo.</p> <p>GUARDE ESTAS INSTRUÇÕES</p>
Advarsel	<p>VIGTIGE SIKKERHEDSANVISNINGER</p> <p>Dette advarselssymbol betyder fare. Du befinder dig i en situation med risiko for legemeskade, og du begynder arbejde på udstyr, skal du være opmærksom på de involverede risici, der er ved elektriske kredsløb, og du skal sætte dig ind i standardprocedurer til undgåelse af ulykker. Brug erklæringsnumrene efter hver advarsel for at finde oversættelsen i de oversatte advarsler, der fulgte med denne enhed.</p> <p>GEM DISSE ANVISNINGER</p>

تحذير	<p>إرشادات الأمان الهامة</p> <p>يوضح رمز التحذير هذا وجود خطر. وهذا يعني أنك متواجد في مكان قد ينتج عنه التعرض لإصابات. قبل بدء العمل، احذر مخاطر التعرض للصدمات الكهربائية وكن على علم بالإجراءات القياسية للحيلولة دون وقوع أي حوادث. استخدم رقم البيان الموجود في آخر كل تحذير لتحديد مكان ترجمته داخل تحذيرات الأمان المترجمة التي تأتي مع الجهاز. قم بحفظ هذه الإرشادات</p>
Upozorenje	<p>VAŽNE SIGURNOSNE NAPOMENE</p> <p>Ovaj simbol upozorenja predstavlja opasnost. Nalazite se u situaciji koja može prouzročiti tjelesne ozljede. Prije rada s bilo kojim uređajem, morate razumjeti opasnosti vezane uz električne sklopove, te biti upoznat sa standardnim načinima izbjegavanja nesreća. U prevedenim sigurnosnim upozorenjima, priloženima uz uređaj, možete prema broju koji nalazi uz pojedino upozorenje pronaći i njegov prijevod.</p> <p>SAČUVAJTE OVE UPUTE</p>
Upozornění	<p>DŮLEŽITÉ BEZPEČNOSTNÍ POKYNY</p> <p>Tento upozorňující symbol označuje nebezpečí. Jste v situaci, která by mohla způsobit nebezpečí úrazu. Před prací na jakémkoliv vybavení si uvědomte nebezpečí související s elektrickými obvody a seznamte se se standardními opatřeními pro předcházení úrazů. Podle čísla na konci každého upozornění vyhledejte jeho překlad v přeložených bezpečnostních upozorněních, která jsou přiložena k zařízení.</p> <p>USCHOVEJTE TYTO POKYNY</p>
Προειδοποίηση	<p>ΣΗΜΑΝΤΙΚΕΣ ΟΔΗΓΙΕΣ ΑΣΦΑΛΕΙΑΣ</p> <p>Αυτό το προειδοποιητικό σύμβολο σημαίνει κίνδυνο. Βρίσκεστε σε κατάσταση που μπορεί να προκαλέσει τραυματισμό. Πριν εργαστείτε σε οποιοδήποτε εξοπλισμό, να έχετε υπόψη σας τα κινδύνους που σχετίζονται με τα ηλεκτρικά κυκλώματα και να έχετε εξοικειωθεί με τις συνήθειες πρακτικές για την αποφυγή ατυχημάτων. Χρησιμοποιήστε τον αριθμό δήλωσης που παρέχεται τέλος κάθε προειδοποίησης, για να εντοπίσετε τη μετάφρασή της στις μεταφρασμένες προειδοποιήσεις ασφαλείας που συνοδεύουν τη συσκευή.</p> <p>ΦΥΛΑΞΤΕ ΑΥΤΕΣ ΤΙΣ ΟΔΗΓΙΕΣ</p>
אזהרה	<p>בטיחות חשובות</p> <p>זהר זה מסמל סכנה. אתה נמצא במצב העלול לגרום לפציעה. לפני שתעבוד עם ציוד עליך להיות מודע לסכנות הכרוכות במעגלים חשמליים ולהכיר את הנהלים המקובלים תאונות. השתמש במספר ההוראה המסופק בסופה של כל אזהרה כדי לאתר את התרגום הבטיחות המתורגמות שמצורפות להתקן.</p> <p>וראות אלה</p>
Opomena	<p>ВАЖНИ БЕЗБЕДНОСНИ НАПАТСТВИЈА</p> <p>Симболот за предупредување значи опасност. Се наоѓате во ситуација што може да предизвика телесни повреди. Пред да работите со опремата, бидете свесни за ризикот и постои кај електричните кола и треба да ги познавате стандардните постапки за спречување несреќни случаи. Искористете го бројот на изјавата што се наоѓа на крајот на секое предупредување за да го најдете неговиот период во преведените безбедносни предупредувања што се испорачани со уредот.</p> <p>ЧУВАЈТЕ ГИ ОБИЕ НАПАТСТВИЈА</p>

Ostrzeżenie	<p>WAŻNE INSTRUKCJE DOTYCZĄCE BEZPIECZEŃSTWA</p> <p>Ten symbol ostrzeżenia oznacza niebezpieczeństwo. Zachodzi sytuacja, która może powodować obrażenia ciała. Przed przystąpieniem do prac przy urządzeniach należy zapoznać się z zagrożeniami związanymi z układami elektrycznymi oraz ze standardowymi środkami zapobiegania wypadkom. Na końcu każdego ostrzeżenia podano numer, na podstawie którego można odszukać tłumaczenie tego ostrzeżenia w dołączonym do urządzenia dokumencie z tłumaczeniami ostrzeżeń.</p> <p>NINIEJSZE INSTRUKCJE NALEŻY ZACHOWAĆ</p>
Upozornenie	<p>DÔLEŽITÉ BEZPEČNOSTNÉ POKYNY</p> <p>Tento varovný symbol označuje nebezpečenstvo. Nachádzate sa v situácii s nebezpečenstvom úrazu. Pred prácou na akomkoľvek vybavení si uvedomte nebezpečenstvo súvisiace s elektrickými obvodmi a oboznámte sa so štandardnými opatreniami na predchádzanie úrazom. Podľa čísla na konci každého upozornenia vyhľadajte jeho preklad v preložených bezpečnostných upozorneniach, ktoré sú priložené k zariadeniu.</p> <p>USCHOVAJTE SI TENTO NÁVOD</p>
Opozorilo	<p>Ta naprava mora biti ozemljena. Nikoli ne odklapljajte ozemljitve oz. upravljajte naprave, ki primerno ozemljena. V primeru, da niste sigurni, ali imate primerno ozemljitev, nemudoma pokličite pooblaščenj električni servis ali električarja.</p>
警告	<p>重要安全性指示 此警告符號代表危險，表示可能造成人身傷害。使用任何設備前，請留心電路相關危險，並熟悉避免意外的標準作法。您可以使用每項警告後的聲明編號，查詢本裝置隨附之安全性警告譯文中的翻譯。請妥善保留此指示</p>

**Warning**

When installing the product, please use the provided or designated connection cables/power cables/AC adapters. Using any other cables/adapters could cause a malfunction or a fire. Electrical Appliance and Material Safety Law prohibits the use of UL-certified cables (that have the “UL” shown on the code) for any other electrical devices than products designated by CISCO. The use of cables that are certified by Electrical Appliance and Material Safety Law (that have “PSE” shown on the code) is not limited to CISCO-designated products.

Statement 371

**Warning**

Read the wall-mounting instructions carefully before beginning installation. Failure to use the correct hardware or to follow the correct procedures could result in a hazardous situation to people and damage to the system.

Statement 378

**Warning**

Read the installation instructions before connecting the system to the power source. **Statement 1004**



Warning To avoid electric shock, do not connect safety extra-low voltage (SELV) circuits to telephone-network voltage (TNV) circuits. LAN ports contain SELV circuits, and WAN ports contain TNV circuits. Some LAN and WAN ports both use RJ-45 connectors. Use caution when connecting cables. **Statement 1021**



Warning This equipment must be grounded. Never defeat the ground conductor or operate the equipment in the absence of a suitably installed ground conductor. Contact the appropriate electrical inspection authority or an electrician if you are uncertain that suitable grounding is available. **Statement 1024**



Warning Connect the unit only to DC power source that complies with the safety extra-low voltage (SELV) requirements in IEC 60950 based safety standards. **Statement 1033**



Warning When installing or replacing the unit, the ground connection must always be made first and disconnected last. **Statement 1046**



Warning Do not locate the antenna near overhead power lines or other electric light or power circuits, or where it can come into contact with such circuits. When installing the antenna, take extreme care not to come into contact with such circuits, because they may cause serious injury or death. For proper installation and grounding of the antenna, please refer to national and local codes (for example, U.S.:NFPA 70, National Electrical Code, Article 810, Canada: Canadian Electrical Code, Section 54). **Statement 1052**



Warning No user-serviceable parts inside. Do not open. **Statement 1073**



Warning Installation of the equipment must comply with local and national electrical codes. **Statement 1074**



Warning Only trained and qualified personnel should be allowed to install, replace, or service this equipment. **Statement 1030**



Warning Ultimate disposal of this product should be handled according to all national laws and regulations. **Statement 1040**

**Warning**

The covers are an integral part of the safety design of the product. Do not operate the unit without the covers installed. **Statement 1077**

**Warning**

Hot surface. **Statement 1079**

Related Documentation

All of the IR1101 documentation can be found online here:

<https://www.cisco.com/c/en/us/support/routers/1101-industrial-integrated-services-router/model.html>

Searching Cisco Documents

To search an HTML document using a web browser, press **Ctrl-F** (Windows) or **Cmd-F** (Apple). In most browsers, the option to search whole words only, invoke case sensitivity, or search forward and backward is also available.

To search a PDF document in Adobe Reader, use the basic Find toolbar (**Ctrl-F**) or the Full Reader Search window (**Shift-Ctrl-F**). Use the Find toolbar to find words or phrases within a specific document. Use the Full Reader Search window to search multiple PDF files simultaneously and to change case sensitivity and other options. Adobe Reader's online help has more information about how to search PDF documents.



CHAPTER 2

Product Overview

This chapter provides an overview of the features available for the Cisco IR1101 Industrial Integrated Services Router and its Expansion Module. It contains the following sections:

- [Product Overview, on page 9](#)

Product Overview

This chapter provides an overview of the features available for the Cisco IR1101 Industrial Integrated Services Router and its Expansion Module. It contains the following sections:



Note Prior to installing this device read the [Regulatory Compliance and Safety Information](#) .

General Description

The Cisco IR1101 Industrial Integrated Services Router is a next generation modular industrial router which has a base module with additional Pluggable Modules that can be added. The Pluggable Module provides the flexibility of adding different interfaces to the IR1101 platform, for example, a cellular module.

The IR1101 ISR also has an Expansion Module that adds key capabilities such as dual LTE Pluggables, mSATA SSD FRU, SFP, and Digital GPIO connections.

Figure 1: The IR1101 Industrial Integrated Services Router



SKU Information

Table 1 lists the different SKUs available for the Cisco IR 1101.

Table 1: Supported SKUs for Cisco IR1101

SKU ID	Description
IR1101-K9	IR1101 Base Unit
IRM-1100-SPMI	Expansion Module with 1 GE SFP, 1 Pluggable Module, 1 Digital I/O Connector, and 1 mSATA SSD Slot.
IRM-1100-SP	Expansion Module with 1 GE SFP and 1 Pluggable Module.
IR1100-SSD-100G	100 GB mSATA SSD
PWR-IE50W-AC	Optional AC power adapter with 110/220V AC and 88-300V DC input (Temperature: -40C to 60C)
IR1101-DINRAIL(=)	Din rail kit and mounting screws for horizontal and vertical mounting
IRM-1100-DINRAIL	Din rail kit for the Expansion Module
IR1101-WALLMNT(=)	Wall mount kit

Cisco IR1101 Series Platform Features

This section describes the different components of the router.

Cisco IR1101 Base Router

The following lists the hardware platform features for the Cisco IR1101.

- External Power Entry
 - Nominal: 12 to 48VDC
 - Absolute min/max: 9.6 to 60VDC
 - Typical current: 0.82A to 0.22A
 - Maximum current: 0.91A to 0.28A
 - 4-pin 3.8 mm EURO power connector
- External Reset/Recovery Push Button
- Gigabit Ethernet Combo RJ45+SFP connector.
 - RJ45 connector will support IEEE802.3 Ethernet over copper wiring standards of 10Base-T, 100Base-TX, and 1000Base-T
 - SFP port will support 1000Base-X or 100Base-FX Fiber Ethernet standard SFP (see the supported list of SFP's here: [SFP Module, page 26](#))
- LAN Ports
 - 4x RJ45 10/100 Fast Ethernet
- Serial Port
 - 1 x RJ45 RS232 Port (DTE)
- USB Ports
 - 1x USB 2.0 Type A Host Port
 - 1x USB 2.0 mini USB Type B console port
- Compliance
 - Class A EMC or better
 - IP30 compliant when vertical and ports downward
- Industrial temperature [-40°C to +60°C, 13.8Kft (operating), 15Kft (non-operating)]
- One alarm input

[Figure 2](#) Shows the IR1101 ISR base router.

Figure 2: Cisco IR1101 Industrial Integrated Services Router



Figure 3 and Figure 4 shows the IR1101 Base Module Front.

Figure 3: Cisco IR1101 Integrated Services Router with USB covers in place

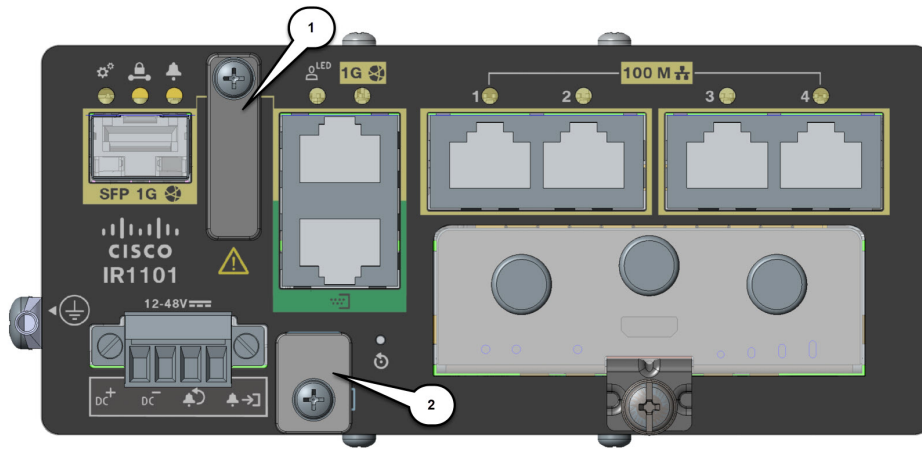

Item	Details
1	USB 2.0 Port Cover
2	Mini-USB Console Cover

Figure 4 shows the front panel details of the Cisco IR1101.

Figure 4: Cisco IR1101 Front Panel

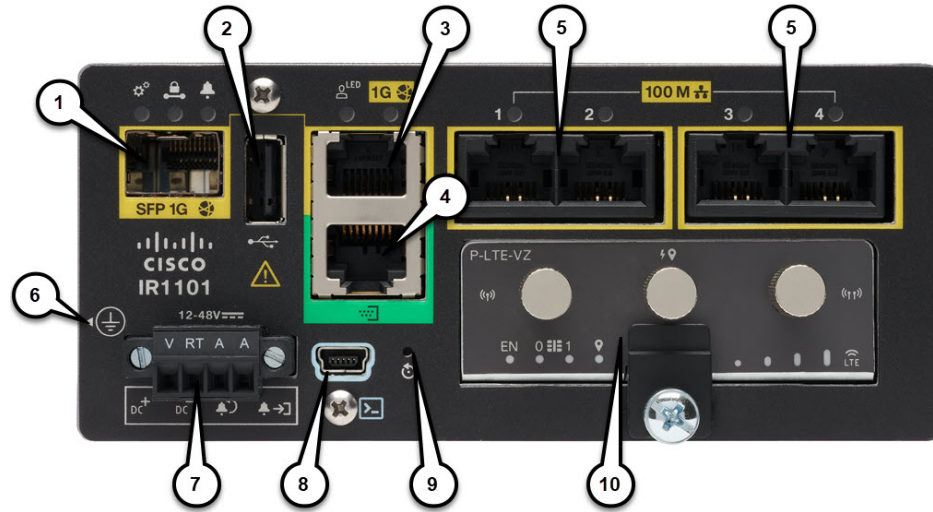

1 SFP GE WAN	6 Grounding Point (on side of device)
2 USB 2.0	7 DC Power and Alarm Input
3 RJ45 GE WAN	8 Mini-USB Console
4 Serial Port	9 Reset Button
5 FE LAN Ports 1-4	10 Pluggable Module

Cisco IRM-1100-SPMI Expansion Module

Figure 5 shows the IR-1100-SPMI Expansion Module.

Figure 5: IR-1100-SPMI Expansion Module



The following lists the hardware platform features for the Cisco IR-1100-SPMI:

- 1 GE SFP (see the supported list of SFP's here: [SFP Module, page 26](#))
- 1 Pluggable slot
- 1 Digital I/O connector
- 1 mSATA SSD slot

Figure 6: IR-1100-SPMI Expansion Module Details

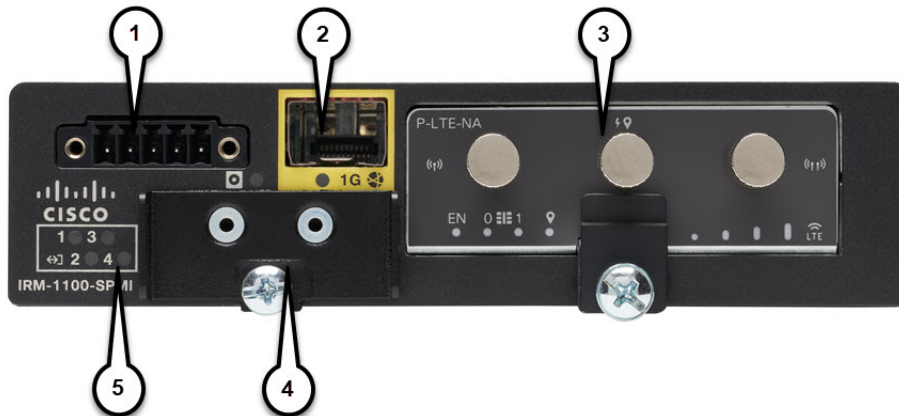

1	4 GPIO + 1 Return (Digital I/O)
2	SFP Connector
3	Pluggable Module
4	mSATA SSD Slot
5	Digital I/O LEDs

Digital I/O Connector

The Digital I/O connector has 4 GPIO connections plus 1 Return connection. The Digital I/O supports Both Dry and Wet contacts up to 60Volts.

- Dry contact is isolated from a voltage source (or “No Volt”), with an embedded relay function (NPN transistor), usually used to indicate an event. For example: open/close, alarm.
- Wet contact is a contact with external power (+3.3V to +60V, max 150mA of current allowed at high voltage) applied, usually used to energize something. For example: solenoid, light.

Figure 7 shows the connector.



Note Digital I/O is only supported on IOS-XE version 16.12.1 and above.



Note The default state of the Digital I/O is input, the open-collector is open (off).

Figure 7: Digital I/O connector

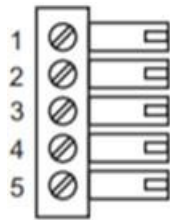

The pinouts for the Digital I/O are described in [Table 2](#).

Table 2: Digital I/O Pinouts

Pin #	Name	Direction	Description
1	DIO1	I/O	Digital IO 1
2	DIO2	I/O	Digital IO 2
3	DIO3	I/O	Digital IO 3
4	DIO4	I/O	Digital IO 4

Pin #	Name	Direction	Description
5	Return	Return	Digital IO Common Return

Digital Input and Output Specifications are described in [Table 3](#) and [Table 4](#).

Table 3 is considered “dry contact”, and Table 4 is considered “wet contact”.

Table 3: Digital Input Specification

Specification	Minimum	Maximum	Unit
Input Voltage High	2.2	60	Volts
Input Voltage Low	-	1.2	Volts
Input Current	-	0.68mA Note1	uA

Note1: Current is flowing out of the terminal although it is an input, i.e. sourcing. The current is flowing in the terminal for the output, i.e. sinking.

Table 4: Digital Output Specification

Specification	Minimum	Maximum	Unit	Notes
Output Voltage High	2.5		Volts	No external voltage applied.
Output Voltage Low	-	0.4	Volts	No external voltage applied.
Internal Pull-up Resistance	3.3K – 1%	3.3K – 1%	Ohms	
Internal Pull-up Voltage	-	3	Volts	
External Pull-up Voltage	3.3	60	Volts	External resistance required to limit current to 200mA.
Sink Current		200	mA	

Common features of the Digital I/O are:

- Withstands up to 60V applied at the terminal.
- Reverse voltage protected and causes no damage to the equipment.
- Digital input and output can coexist on different channel.
- LED Indicator: provision-able, On: Active, Off: Non-active.
- Electrical isolation: 2000 VDC.
- 4kV Surge protected (IEC 61000-4-5).

IR-1100-SPMI Expansion Module LEDs

There are 6 LEDs in the Expansion Module. Four LEDs show the status of digital input and output. One LED shows the SFP port status and one LED shows the mSATA status. The LED behavior is shown in [Table 5](#).

Table 5: Expansion Module LEDs

LED	Definition
Digital I/O as Input	Off - Inactive Solid Yellow - Active
Digital I/O as Output	Off - Inactive Solid Yellow - Active
SFP	Off - No Link Solid Yellow - Port link with no activity Flashing Yellow - Port link healthy with activity
mSATA	Off - Not powered on or no activity Flashing Green - mSATA being accessed

Cisco IR-1100-SP Expansion Module

The IR-1100-SP Expansion Module is the same as the IR-1100-SPMI module, without the Digital I/O and mSATA components.

The following lists the hardware platform features for the Cisco IR-1100-SP:

- 1 GE SFP (see the supported list of SFP's here: [SFP Module, page 26](#))
- 1 Pluggable slot

Cisco Pluggable Module

The Pluggable Module provides the flexibility of adding different interfaces to the IR1101 platform, for example, a cellular module.

Pluggable LTE Module

Highlights of the LTE Pluggable Module are:

- All Cellular interfaces are supported through a Pluggable Module
- Micro-Sim, 3FF size. Cisco recommends Industrial Temp micro SIMs that are rated from -40C to +105C.

Figures [Figure 8](#) and [Figure 9](#) show an example of a Pluggable Module. In this case, the LTE Pluggable Module.

Figure 8: LTE Pluggable Module (front)

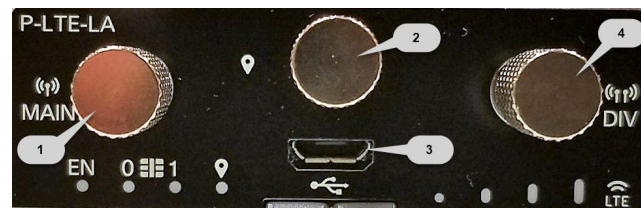

1	LTE-Main SMA
2	GPS SMA

1	LTE-Main SMA
3	Micro USB Debug Port
4	LTE-Div SMA

Figure 9: LTE Pluggable Module (with antennas)



LTE Category 18 Pluggable Module

This module has a new smaller form factor SMA Diversity Antenna for usability and Micro-USB port access.



Note

The P-LTEAP18-G pluggable module must be installed in the IR1101 Base. It cannot be used in the IRM-1100 Expansion Module.

Figure 10: LTE Pluggable - P-LTEAP18-GL

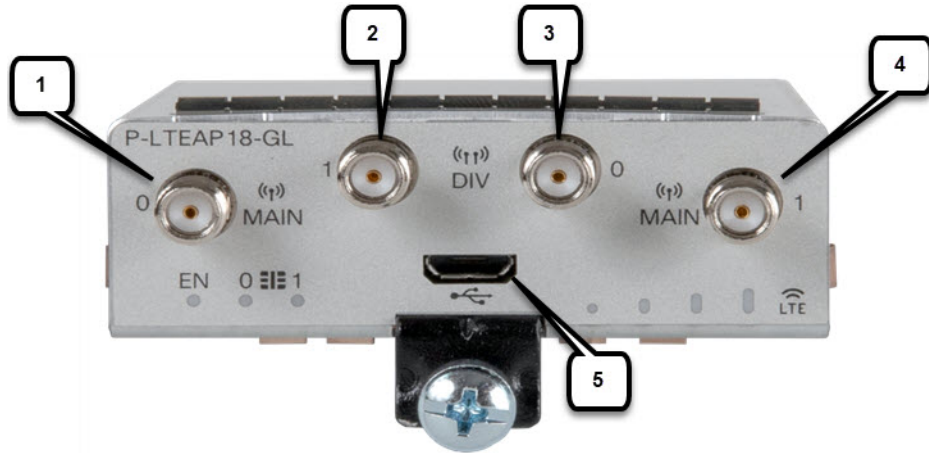

Item	Description
1	Main 0 Antenna
2	Diversity 1 Antenna
3	Diversity 0 Antenna
4	Main 1 Antenna
5	Micro USB Debug Port

Installing or replacing the SIM modules is covered in [Pluggable Module, on page 39](#)

P-LTEAP18-GL Frequency Bands

The following table provides the global frequency bands available.



Note Antennas must be attached to the RF connectors as listed below for proper bands service.

Item	Description
MAIN 0 and DIV 0	B1, B2(B25), B3, B4(B66), B5(B26,B18,B19), B8, B12(B17), B13, B14, B20, B28, B29, B39, B71, B41
MAIN 1 and DIV 1	B7, B30, B32, B38, B40, B41, B42, B46, B48, B2(B25)

mSATA Module

Mini-SATA, or mSATA, is a low-profile interface connector that enables more effective Serial ATA (SATA) integration in small form-factor drives roughly the size of a business card, such as solid state disks (SSDs). The mSATA Pluggable Module plugs into the IR-1100-SPMI Expansion Module. [Figure 10](#) shows the mSATA Pluggable Module.

Figure 11: mSATA Pluggable Module

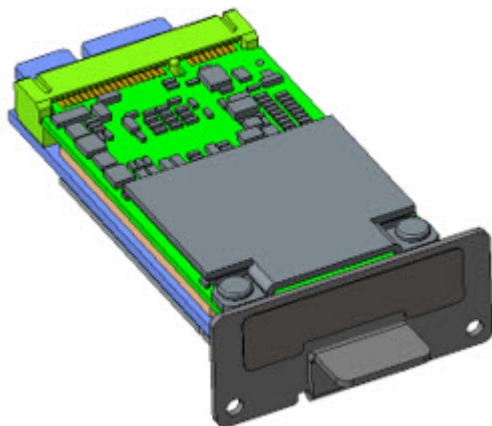

Highlights of the mSATA Pluggable Module are:

- Provides an additional 100GB of additional flash memory storage
- Main purpose is to provide space to store application data for IOx
- Field Replaceable unit, but is not hot-swappable.

Front Panel Icons and LEDs

The IR1100 Series uses icons to show the different features of the device. [Table 6](#) shows Icons and their associated LEDs with descriptions. [Table 7](#) shows the Icons without associated LEDs and their descriptions.

Table 6: Icons with LEDs

Icon	Description/Activity	Icon	Description/Activity
	System - Power and System Status. Off — No power Green Steady on — Normal operation Green Flashing — Boot up phase or in ROM Monitor mode Amber Steady on — Power is OK but possible internal failure		Alarm - Alarm Input Status Off — Normal operation Red - Alarm State on the Alarm Input
	VPN Off — No VPN tunnel Steady Green — At least one VPN tunnel is up		Red, Green, and Blue User Configurable LED

















Icon	Description/Activity	Icon	Description/Activity
	Gigabit Ethernet Combo Port Off — No Link Solid Green — Copper Link up, no activity Flashing Green — Copper Link up, with activity Solid Amber — SFP Link up, no activity Flashing Amber — SFP Link up, with activity		RJ45 Fast Ethernet Ports -Link Status 0:1 Off — No link Steady Green — Link is up Flashing — Transmitting and Receiving data
	mSATA Storage Off - Not powered on or no activity Flashing Green - mSATA being accessed		Digital I/O Off - Inactive Solid Yellow- Active

Table 7: Icons only

Icon	Description	Icon	Description
	USB 2.0 Console Mini-B Connector		USB 2.0 Type A Port for Storage and Networking
	Grounding point (located on side of device)		Reset Button
	DC Power Input (12V to 48V)		DC Power Return
	Alarm Return		Alarm IN
	Serial Ports		Warning
	Expansion Module (Top or Left side)		Expansion Module (Bottom or Right side)

Memory

The Cisco IR1101 uses flash memory and main memory. The flash memory contains the Cisco OS software image and the boot flash contains the ROMMON boot code. The memory includes:

- 4 GB DRAM (soldered down)
- 4 GB onboard flash memory

Reset Button

The Reset button resets the router configuration to the default configuration set by the factory. To restore the router configuration to the default configuration set by the factory, use a standard size #1 paper clip with wire gauge 0.033 inch or smaller and simultaneously press the reset button while applying power to the router.

Supported Cisco Antennas and Antenna Accessories

The IR1101 must have a Pluggable Module with antenna ports installed in order to connect antennas. The base unit does not have any wireless capabilities on its own.

The [Antenna Selection and Installation](#) chapter lists the supported Antennas and Accessories for the Cisco IR1101 with a wireless Pluggable Module. For detailed information about Cisco Antennas for the Industrial Routers, please refer to the following guide:

Cisco Industrial Routers and Industrial Wireless Access Points Antenna Guide:

<http://www.cisco.com/c/en/us/td/docs/routers/connectedgrid/antennas/installing-combined/industrial-routers-and-industrial-wireless-antenna-guide.html>

Modem Support

The Cisco IR1101 wireless Pluggable Module uses the Sierra Wireless series modems. The software download page can be found here:

<https://software.cisco.com/download/navigator.html?mdfid=286288566&flowid=76082>

[Table 8](#) and [Table 9](#) shows the technology details for the modems.

Table 8: Modem Technology Supported

SKU ID	Modem Used	Description	Technology Supported
P-LTE-VZ	WP7601-G	U.S. (Verizon) Single Micro SIM	LTE CAT4: B4, B13
P-LTE-US	WP7603-G	North America (AT&T) Dual Micro SIM	LTE CAT4: B2, B4, B5, B12 3G UMTS DC-HSPA+, HSPA+, HSPA, WCDMA: B2, B4, B5
P-LTE-JN	WP7605-G	Japan	LTE CAT4: B1, B3, B8, B11, B18, B19, B21 3G UMTS HSPA+

SKU ID	Modem Used	Description	Technology Supported
P-LTE-GB	WP7607-G	Europe Dual Micro SIM	LTE CAT4: B1,B3, B7, B8, B20, B28 3G UMTS DC-HSPA+, HSPA+, HSPA, WCDMA GPRS/EDGE: 900/1800
P-LTE-IN	WP7608-G	India and China	LTE CAT4: B1, B3, B5, B8, B40, B41* 3G UMTS DC-HSPA+ * B41 supported frequency range: (2535–2655 MHz)
P-LTE-MNA	WP7610-G	North America	LTE CAT4: B2, B4, B5, B12, B13, B14, B17, B66 3G UMTS DC-HSPA+, HSPA+, HSPA, WCDMA
P-LTEA-LA	EM7430	APAC	Multimode LTE 3.0 for carriers that operate FDD LTE 700-MHz (band 28), 850-MHz (band 5 CLR), 850-MHz (bands 18 and 19 Low), 900-MHz (band 8), 1500-MHz (band 21), 1800-MHz (band 3), 2100-MHz (band 1), or 2600-MHz (band 7) networks; the multimode Cisco LTE Advanced 3.0 NIMs are backward-compatible with UMTS and DC-HSPA+: 800 MHz (band 19 Japan), 850 MHz (band 5), 850 MHz (band 6 Japan), 900 MHz (band 8), 1800 MHz (band 9), 2100 MHz (band 1), and TD-SCDMA 39. Multimode LTE Advanced 3.0 for carriers that operate TDD LTE 1900 MHz (band 39), 2300 MHz (band 40), 2500 MHz (band 41), or 2600 MHz (band 38). Multimode LTE Advanced 3.0 for carrier aggregation band combinations: 1+(8,18,19,21); 3+(5,7,19,28); 7+(5,7,28); 19+21, 38+38, 39+39, 40+40, and 41+41.

SKU ID	Modem Used	Description	Technology Supported
P-LTEA-EA	EM7455	USA, Canada, Europe, Latin America	<p>Multimode LTE Advanced 3.0 for carriers that operate FDD LTE 700-MHz (band 12), 700-MHz (band 29), 800-MHz (band 20), 850-MHz (band 5 CLR), 850-MHz (bands 26 Low), 900-MHz (band 8), 1800-MHz (band 3), 1900-MHz (band 2), 1900-MHz (PCS band 25), 1700-MHz and 2100-MHz (band 4 AWS), 2100-MHz (band 1), 2300-MHz (band 30), or 2600-MHz (band 7) networks. The multimode Cisco LTE Advanced 3.0 NIMs are backward compatible with Universal Mobile Telecommunications Service (UMTS) and Dual-Carrier High-Speed Packet Access Plus (DC-HSPA+): 850-MHz (band 5), 900-MHz (band 8), 1800-MHz (band 3), 1900-MHz (band 2), 1700-MHz and 2100-MHz (band 4 AWS), and 2100-MHz (band 1).</p> <p>Multimode LTE Advanced 3.0 for carriers that operate TDD LTE 2500-MHz (band 41).</p> <p>Multimode LTE Advanced 3.0 for carrier aggregation band combinations: 1+8; 2+(2,5,12,13,29); 3+(7,20); 4+(4,5,12,13,29); 7+(7,20); 12+30, 5+30, and 41+41.</p>
<p>P-LTEAP18-GL, Cisco LTE Advanced Pro Pluggable 3GPP Category 18</p> <p>Note Supported only in the IR1101 Base Unit. Not supported in the IRM-1100 Expansion Module.</p> <p>Note GNSS is not supported on the CAT18 module.</p>	LM960AP18	United States, Europe, Canada, Japan, Australia and New Zealand.	<p>LTE bands 1-5, 7, 8, 12-14, 17, 18-20, 25, 26, 28-30, 32, 38-43, 46, 48, 66, and 71.</p> <p>FDD LTE 600 MHz (band 71), 700 MHz (bands 12, 13, 14, 17, 28, and 29), 800 MHz (band 20), 850 MHz (bands 5, 18, 19, and 26), 900 MHz (band 8), 1500 MHz (band 32), 1700 MHz (bands 4 and 66), 1800 MHz (band 3), 1900 MHz (bands 2 and 25), 2100 MHz (band 1), 2300 MHz (band 30), 2600 MHz (band 7).</p> <p>TDD LTE 1900 MHz (band 39), 2300 MHz (band 40), 2500 MHz (band 41), 2600 MHz (band 38), 3500 MHz (bands 42 and 48), 3700 MHz (band 43), 5200 MHz (band 46).</p>

Table 9: GNSS Technology Support

Technology	RF Band	Receive (Rx) Band MHz	Support
GNSS	GPS	1575.42 +/- 1.023	Supported
	GLONASS	1597.52 - 1605.92	Not Supported
	Galileo	1575.42 +/- 2.046	Not Supported
	BeiDou	1561.098 +/- 2.046	Not Supported

Power Supply

The Cisco IR1101 comes with an external DC power connector. The 4-pin power entry connector (receptacle) is mounted to the unit. The 4-pin power entry mating connector (plug) is attached to the receptacle. It is removed during installation and used to connect to the DC power source, then reattached to provide power to the unit.

Refer to [Figure 11](#) for the location and values of the power connector.

Figure 12: Power Connector Pin-Outs

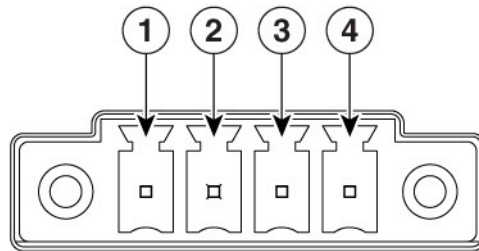

366912

Pin Number	Name	Description
1	DC In +	DC Power Positive Input
2	DC In -	DC Power Return
3	ALM REF	Alarm Common
4	ALM IN	Alarm Input

RJ45 Ports

The IR1101 supports one **ISOLATED** RS232 port which conforms to EIA-561 standard.

The RJ45 pinouts are shown in [Figure 12](#).

Figure 13: S0 Characteristics

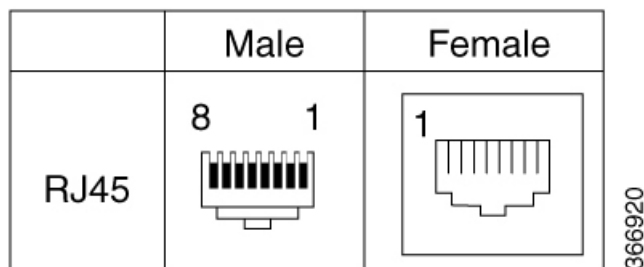

The RS232 port is a DTE and its pin out is shown in [Table 10: S0 Details, on page 26](#).

Table 10: S0 Details

Pin Number	Description	Abbreviation	DTE
1	DCE Ready, Ring Indicator	DSR/RI	<—
2	Received Line Signal Detector	DCD	<—
3	DTE Ready	DTR	—>
4	Signal Ground	COM	
5	Received Data	RxD	<—
6	Transmitted Data	TxD	—>
7	Clear To Send	CTS	<—
8	Request To Send	RTS	—>

SFP Module

Warning: Class 1 laser product. **Statement 1008**

The IR1101 Ethernet SFP module provides connections to other devices. These field-replaceable transceiver modules provide the uplink interfaces. Local connectors (LCs) provide the fiber-optic connection. RJ-45 connectors allow copper connections. You can use any combination of the supported SFP modules listed in the table that follows.

Note: The IR1101 is designed to operate in the Industrial temperature range (-40C to +85C internal component temperature range) and therefore cannot support commercial rated SFPs.

Table 11: Supported Gigabit SFPs

GE SFP	Distance	Fiber	Commercial 0C to +70C	Extended -5C to +85C	Industrial -40C to +85C	DOM
GLC-SX-MM-RGD	220-550 m	MMF			YES	
GLC-LX-SM-RGD	550m/10 km	MMF/SMF			YES	
GLC-ZX-SM-RGD	70 km	SMF			YES	YES
SFP-GE-S	220-550 m	MMF		YES		YES
SFP-GE-L	550 m/10 km	MMF/SMF		YES		YES
SFP-GE-Z	70 km	SMF		YES		YES

Table 12: Supported FE SFPs

FE SFP	Distance	Fiber	Commercial 0C ~ +70C	Extended -5C ~ +85C	Industrial -40C ~ +85C	DOM
GLC-FE-100FX-RGD	2 km	MMF			YES	
GLC-FE-100LX-RGD	10 km	SMF			YES	

For the most up-to-date list of supported SFP models for Cisco Industrial Ethernet switches, see http://www.cisco.com/en/US/docs/interfaces_modules/transceiver_modules/compatibility/matrix/OL_6981.html#wp138176



CHAPTER 3

Installing the Router

This chapter describes the equipment and the procedures for successfully installing the Cisco IR1101 ISR. There is a separate section for installing the IR1101 with an Expansion Module.

- [Installing the Router, on page 29](#)

Installing the Router

This chapter describes the equipment and the procedures for successfully installing the Cisco IR1101 ISR. There is a separate section for installing the IR1101 with an Expansion Module here: [Installing the Router, on page 29](#)

This section contains the following sections:

CAUTION: Do not install the router or power supplies next to a heat source of any kind, including heating vents.

WARNING: Read the installation instructions before connecting the system to the power source. **Statement 1004**

WARNING: Only trained and qualified personnel should be allowed to install, replace, or service this equipment. **Statement 1030**

WARNING: Ultimate disposal of this product should be handled according to all national laws and regulations. **Statement 1040**

WARNING: Do not locate the antenna near overhead power lines or other electric light or power circuits, or where it can come into contact with such circuits. When installing the antenna, take extreme care not to come into contact with such circuits, because they may cause serious injury or death. For proper installation and grounding of the antenna, please refer to national and local codes (for example, U.S.:NFPA 70, National Electrical Code, Article 810, Canada: Canadian Electrical Code, Section 54). **Statement 1052**

WARNING: No user-serviceable parts inside. Do not open. **Statement 1073**

WARNING: This product is not intended to be directly connected to the Cable Distribution System. Additional regulatory compliance and legal requirements may apply for direct connection to the Cable Distribution System. This product may connect to the Cable Distribution System ONLY through a device that is approved for direct connection. **Statement 1078**

WARNING: A minimum of 1 inch clearance is required on all sides of the product when mounting in either horizontal or vertical orientation. Stacking heat-dissipating objects on top of the router is not allowed. I/O

side clearance is needed as it is required to access the cable connections. Clearance is required to attach, mount the DIN rail bracket, and Wall mount bracket.

Equipment, Tools, and Connections

This section describes the equipment, tools, and connections necessary for installing your Cisco IR1101.



Note No antenna is shipped with the IR1101 by default.

Items Shipped with your Router

Unpack the box and verify that all items listed on the invoice were shipped with the Cisco IR1101.

The following items are shipped with your router:

- Getting Started/Product Document of Compliance
- Grounding Lug Kit
- Power Connector

Additional Items

The following items are not shipped with the router but are required for installation:

- ESD-preventive cord and wrist strap.
- Wire crimper for chassis grounding.
- Wire for connecting the chassis to an earth ground.
- Ethernet cables for connecting to the Fast Ethernet (FE) WAN and LAN ports.
- Ratcheting torque flathead screwdriver that exerts up to 15 in-lb (1.69 N-m) of pressure.
- A number-2 Phillips screwdriver.

Ethernet Devices

Identify the Ethernet devices that you will connect to the router: hub, servers, and workstations or PCs. Ensure that each device has a network interface card (NIC) for connecting to Ethernet ports.

Installing the Router

This section describes how to install the Cisco IR1101. This router can be installed in the following ways:

- Table top
- Flat horizontal surface
- Mounted on a wall
- Using a DIN rail

Warnings

WARNING: For NEC-compliant grounding, use size 16awg (1.5mm²) or larger copper wire and a ring terminal with an inner diameter of 1/4 in. (6 to 7mm).

Mounting on a Wall, Table, or Other Flat Surface

The Cisco IR1101 can be mounted in a vertical or horizontal orientation. It can be mounted to a wall or other flat surface, and can also be mounted to a DIN rail.



Note See the [Installing the Router, on page 29](#) for limitations on mounting with the IRM-1100 attached.



Tip When choosing a location for wall-mounting the router, consider cable limitations and wall structure.

WARNING: Read the wall-mounting instructions carefully before beginning installation. Failure to use the correct hardware or to follow the correct procedures could result in a hazardous situation to people and damage to the system. **Statement 378**

WARNING: A minimum of 1 inch clearance is required on all sides of the product when mounting to allow for proper air flow.

The wall mounting kit contains the following:

- Mounting brackets (x2)
- Mounting screws (x4)

To mount the router on a wall or other flat surface, follow these steps:

Step 1 Attach the mounting brackets to the bottom of the router. Refer to [Figure 14: Cisco IR1101 Mounting Bracket, on page 32](#) for guidance.

Figure 14: Cisco IR1101 Mounting Bracket

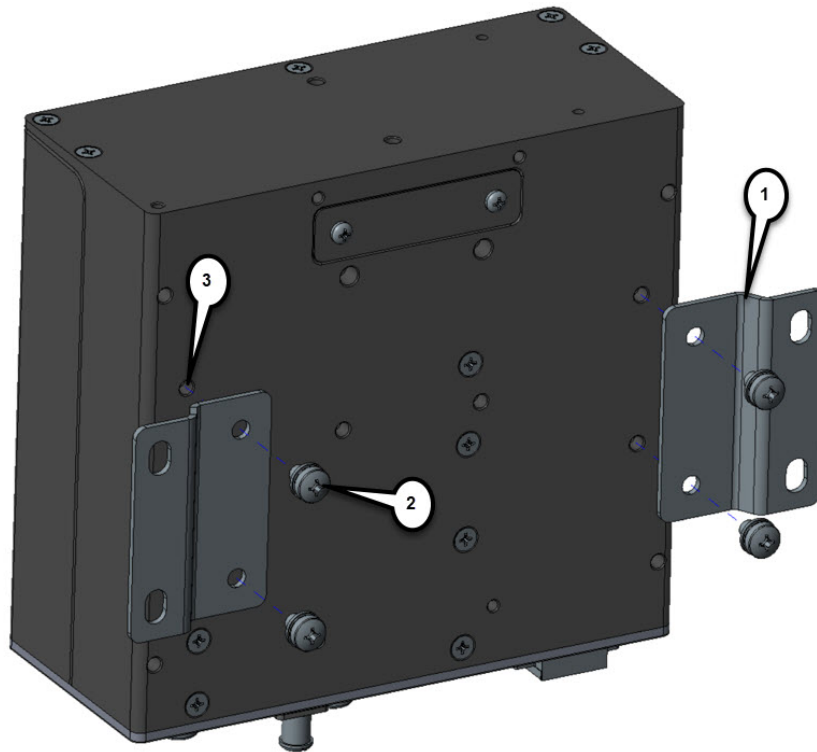

- Step 2** Align the mounting brackets (1) over the mounting holes (3) so that the larger holes on the brackets extend out over the router.
- Step 3** Attach the brackets to the router with the 4 screws (2) provided using a Phillips head driver. Torque to 13-15 in. lbs.
- Step 4** Mount the router with the attached brackets in a proper wall structure to carry the weight of the device. See [Figure 15: Wall/Floor mounting hole dimensions with mounting brackets attached, on page 33](#) and [Figure 16: Wall/Floor mounting clearance and overall dimensions with mounting brackets attached, on page 34](#) for the dimensions of the mounting holes with the brackets attached to the router

Figure 15: Wall/Floor mounting hole dimensions with mounting brackets attached

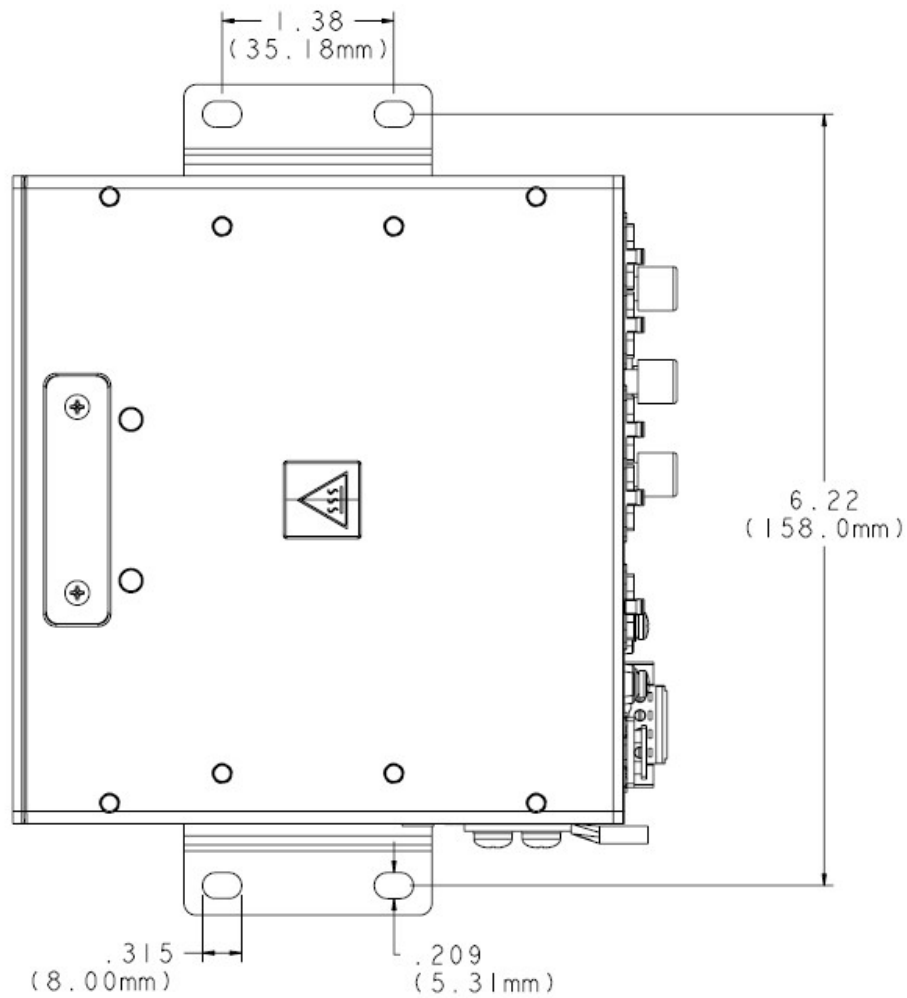

Note Four #10-32 screws are recommended when mounting the unit with these brackets attached to the neighboring surface.

Figure 16: Wall/Floor mounting clearance and overall dimensions with mounting brackets attached

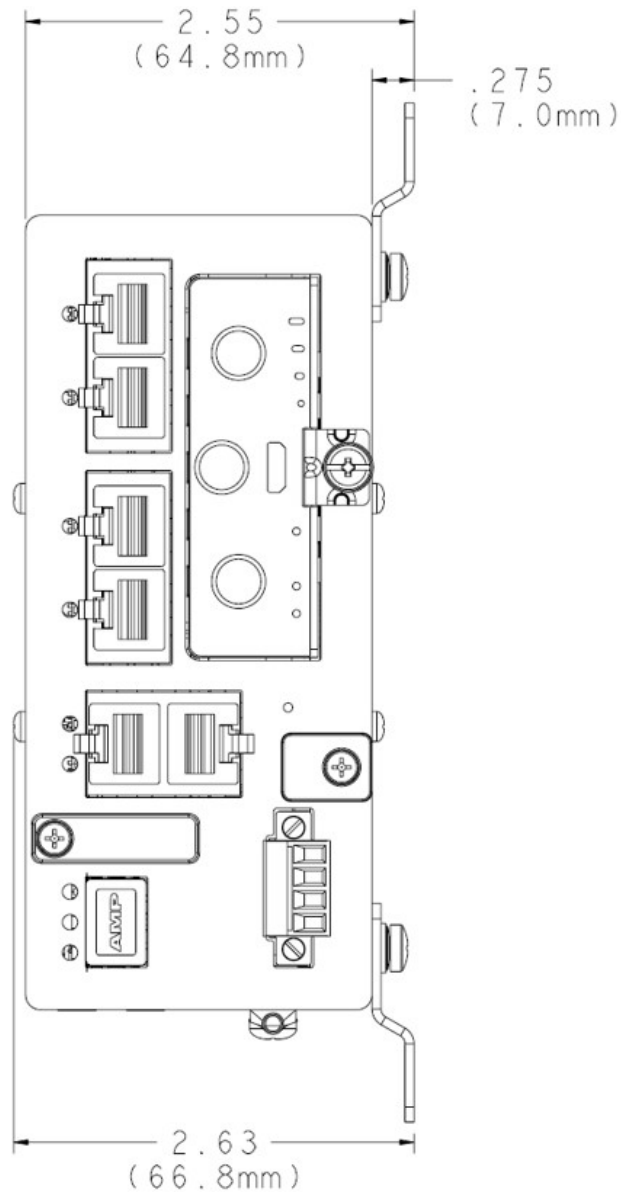

Step 5 Route the cables so that they do not put a strain on the connectors or mounting hardware.

Installing a DIN Rail

The DIN Rail kit is ordered separately.



Note The DIN Rail can be installed on the Base IR1101 in two different orientations, horizontally and vertically. If the Base IR1101 has an Expansion Module attached, horizontal DIN mounting is not supported.

To attach the DIN rail bracket to the Cisco IR1101, follow these steps.

Mounting the DIN Rail Bracket on the Router

Step 1

First, attach the DIN rail bracket to the back of the router. The DIN rail bracket mounts in two different ways, depending on the orientation you wish to use. See the following two figures for vertical orientation, and for horizontal orientation.

Figure 17: Attaching the DIN Rail Bracket for vertical mounting

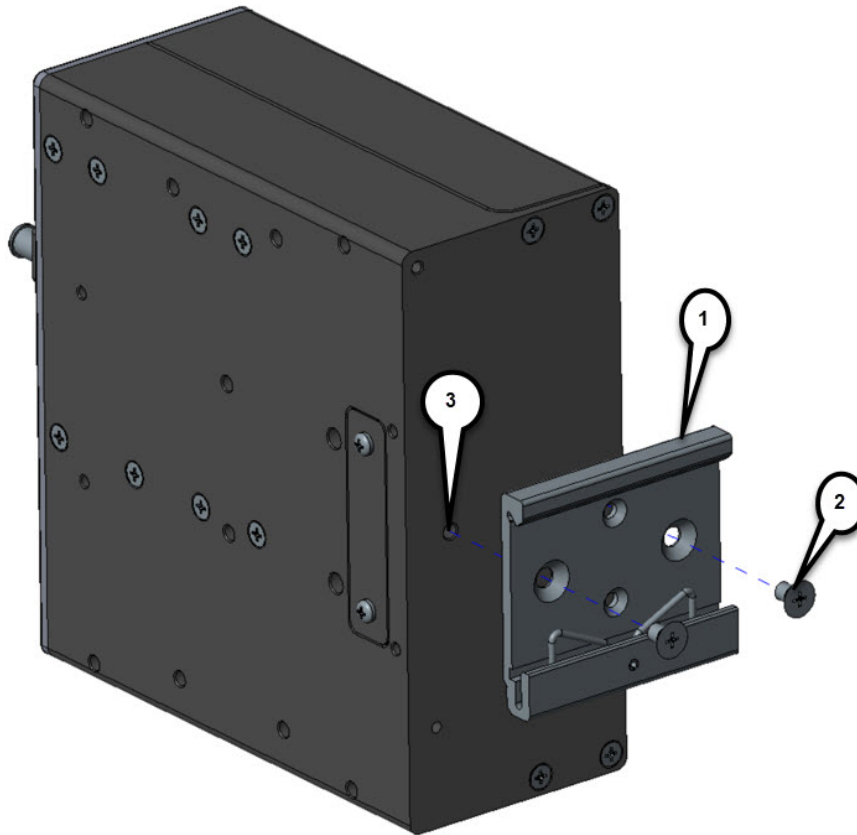

Note Position the router with the ground lug facing down for vertical mounting.

Figure 18: Attaching the DIN Rail Bracket for horizontal mounting

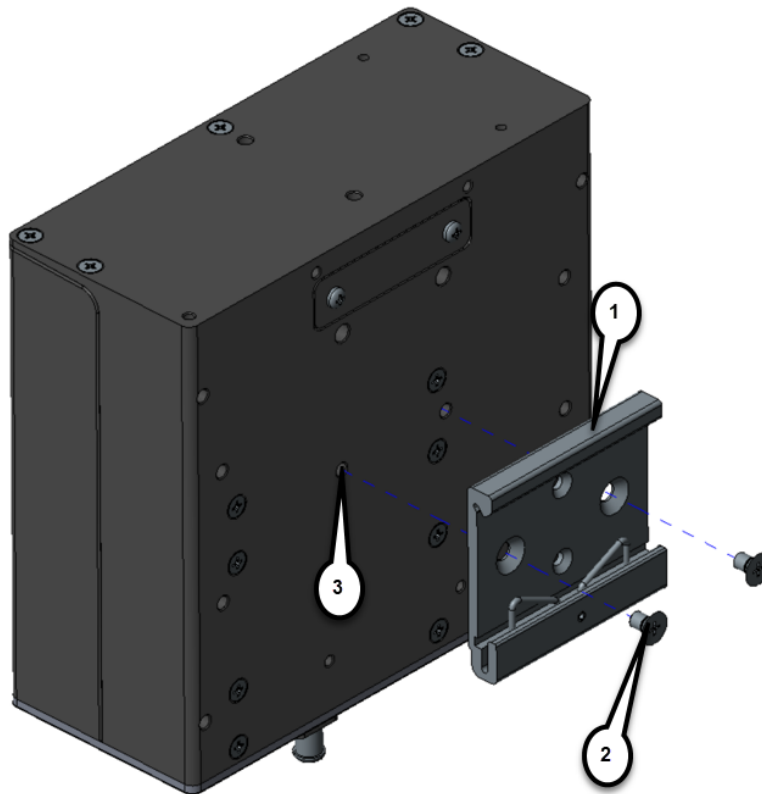

Note Position the router with the front ports facing down for horizontal mounting.

- Step 2** Attach the DIN mounting bracket (1) to the router using the two screws provided in the kit (2). Position the bracket over the two mounting holes (3) that correspond to your orientation. Then use 13-15 in. lbs. of torque to screw the bracket onto the router.
- Step 3** Once the bracket is attached to the router, it can be mounted onto the DIN Rail.

Attaching the Bracket onto the DIN Rail

To attach the Cisco IR101 with the bracket to a DIN rail, follow these steps. Refer to the following figure for details.

Figure 19: Attaching the Bracket to the DIN Rail

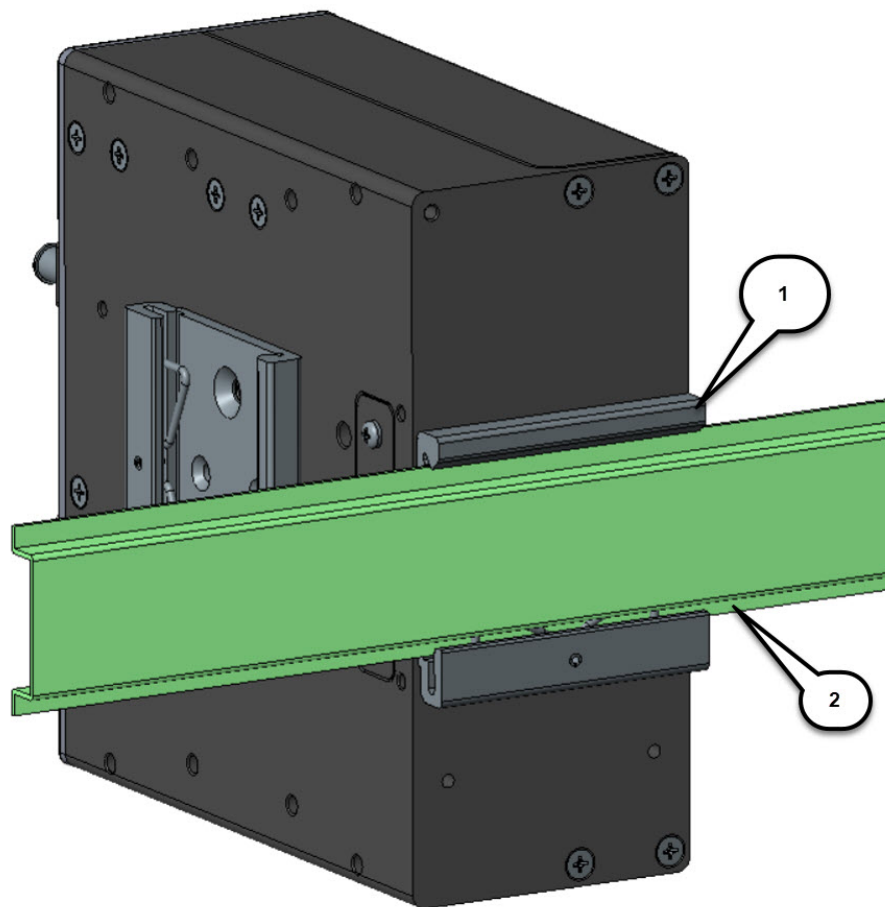

-
- Step 1** Position the router so that the lower edge and spring of the Din clip (1) engages with the bottom section of the Din rail (2).
- Step 2** Push up on the router so that the spring of DIN clip (1) compresses against the lower section of DIN rail (2) and then rotate the router so that the top hook of the DIN clip (1) clamps to the top section of DIN rail (2).
- Step 3** To remove the router from the DIN Rail, simply reverse the procedure.
-

What to do next



Note The procedure to attach the unit to the rail is the same with both orientations.



Note In order to prevent excessive side to side movement of the unit it is advised to install DIN rail stop plates such as Mouser part Numbers 653-PFP-M, 651-1201662 or 845-CA402. These stop plates can be installed on one or both sides of the unit to limit excessive side to side movement that typically occurs in high vibration environments.

Installing the Router Ground Connection

The router must be connected to a reliable earth ground. Install the ground wire in accordance with local electrical safety standards. There are separate grounding points on the Base IR1101 and the Expansion Module.

- For NEC-compliant grounding, use size 16awg (1.5mm²) or larger copper wire and a ring terminal with an inner diameter of 1/4 in. (6 to 7mm).
- For EN/IEC 60950-compliant grounding, use size 18 AWG (1 mm²) or larger copper wire.

WARNING: This equipment must be grounded. Never defeat the ground conductor or operate the equipment in the absence of a suitably installed ground conductor. Contact the appropriate electrical inspection authority or an electrician if you are uncertain that suitable grounding is available. **Statement 1024**

CAUTION: Cable distribution system should be grounded (earthed) in accordance with ANSI/NFPA 70, the National Electrical Code (NEC), in particular Section 820.93, Grounding of Outer Conductive Shield of a Coaxial Cable.

To install the ground connection, follow these steps:

-
- Step 1** Locate the grounding lug (1) attached to the side of the Cisco IR1101. It will be attached underneath two screws. Remove the screws holding it to the router and set it aside for reuse.
- Step 2** Strip one end of the ground wire to the length required for the terminal.
- Step 3** Crimp the ground wire to the grounding lug using the wire crimper.
- Step 4** Attach the grounding lug (1) to the chassis using the screws set aside in step 1. Tighten the screw to a torque of 8 to 10 inch-pound (0.9 to 1.1 newton meter). (See [Figure 20: Chassis Ground Connection Points, on page 39](#).)

Figure 20: Chassis Ground Connection Points



Step 5 Connect the other end of the ground wire to a known reliable earth ground point at your site.

Step 6 If you are using this router in a vehicle, attach the ring terminal to the chassis using one of the screws provided and the green or green and yellow striped wire. Connect the other end of the wire to the vehicle ground.

What to do next

After you install and properly ground the router, you can connect the power wiring, the LAN cables, and the cables for administrative access as required for your installation.

Pluggable Module

The Pluggable Module provides the IR1101 with a number of different configuration options. In this section the modular cellular modem Pluggable Module remove and replace option is shown.

The IR1101 may have a blank plate covering the Pluggable Module slot. This will need to be removed prior to installing the cellular modem module. The following example shows the LTE Pluggable Module.

Step 1 Remove the blank plate by unscrewing the latch lock screw(1) that holds the plate secure. See [Figure 21: Latch Lock Screw, on page 40](#).

Figure 21: Latch Lock Screw



Step 2 Slide the blank plate out of the device.

Step 3 Prepare the cellular modem module by inserting the micro sims applicable for your modems into the device. Remove the screw (1) holding the access plate in place that covers the sim slots. It is located on the side of the module, as shown in .

Figure 22: Sim Access Plate Removal

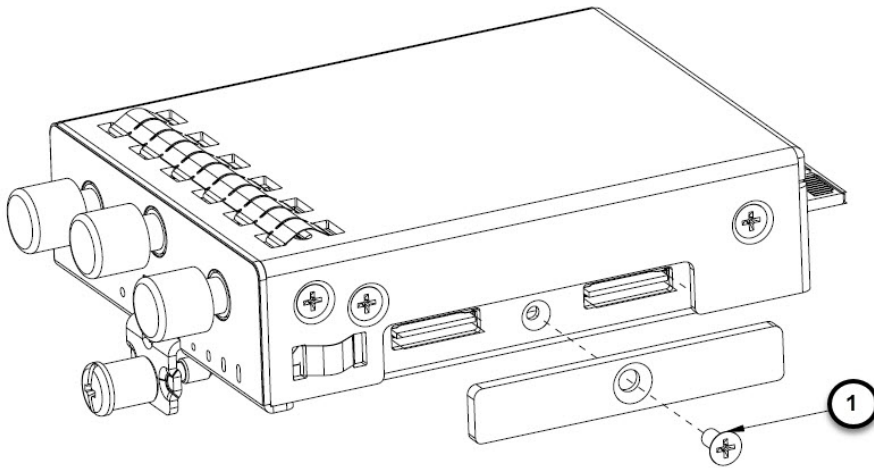

Step 4

Install your sims as shown in [Figure 23: Sim Installation, on page 41](#). Make note of the proper slot number and sim orientation.

Figure 23: Sim Installation

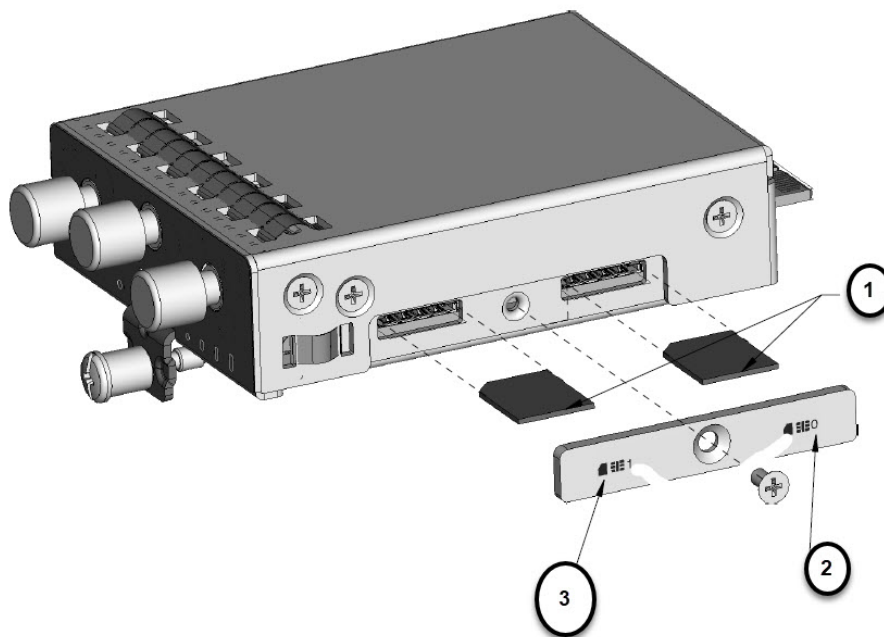

Item	Description
1	Micro SIMs
2	SIM 0 (towards the device)

Item	Description
3	SIM 1 (away from device)

Step 5 Push in each SIM until it clicks into place. When the SIMs are installed, re-attach the access plate previously removed with a screwdriver. Torque to 2.8 to 3.8 inch-lbs (0.9-1.1 newton meter).

Note: Ensure the cover is properly aligned with the screw hole.

Step 6 If your Pluggable Module is the type that has a USB port, make sure that the USB cover is properly installed. Place the USB cover (1) with the plug indentation against the USB port (2). The half circle of the USB cover fits behind the latch lock screw. See [Figure 24: USB Port Cover Installation, on page 42](#) for details.

Figure 24: USB Port Cover Installation

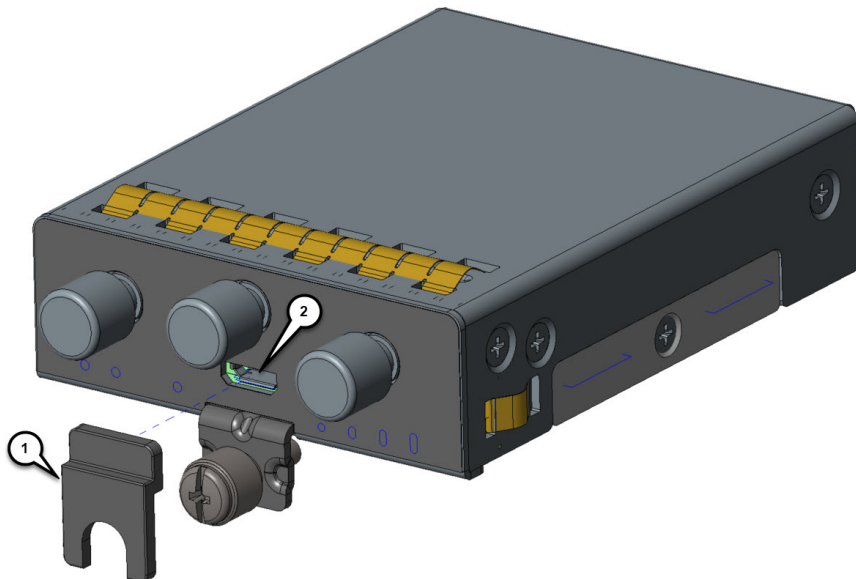

Step 7 Tighten the latch lock screw to a torque of 2.8 to 3.8 inch-lbs (0.3 to 0.4 newton meter). Refer to [Figure 25: USB Cover Finished Installation, on page 43](#) for a finished USB cover installation.

Figure 25: USB Cover Finished Installation

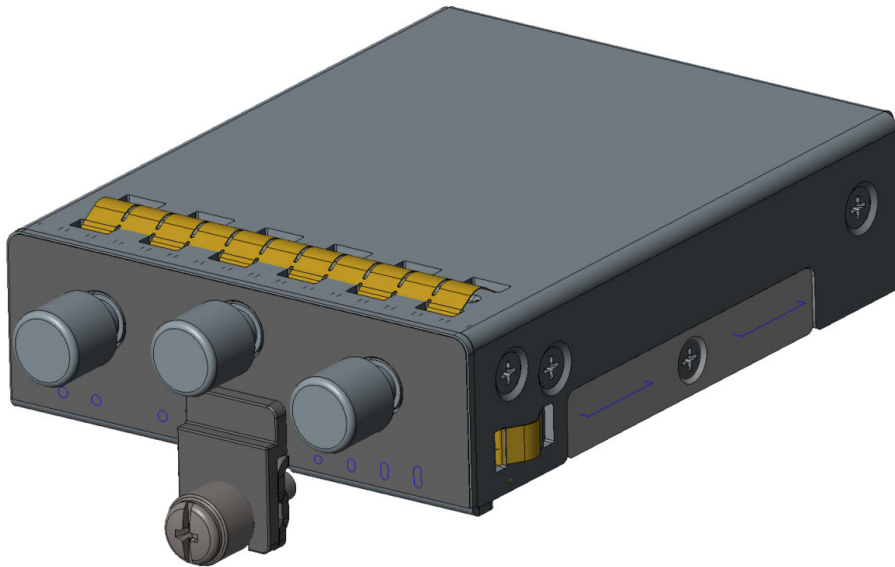

Step 8

Slide the Pluggable Module into the device as shown in [Figure 26: Pluggable Module Insert, on page 44](#). The latch lock screw (1) aligns with the screw hole (2) on the front of the device. Push the Pluggable Module all the way into the device until you feel it seat, and then torque the latch lock screw 8-10 inch-pound (0.9 to 1.1 newton meter).

Figure 26: Pluggable Module Insert

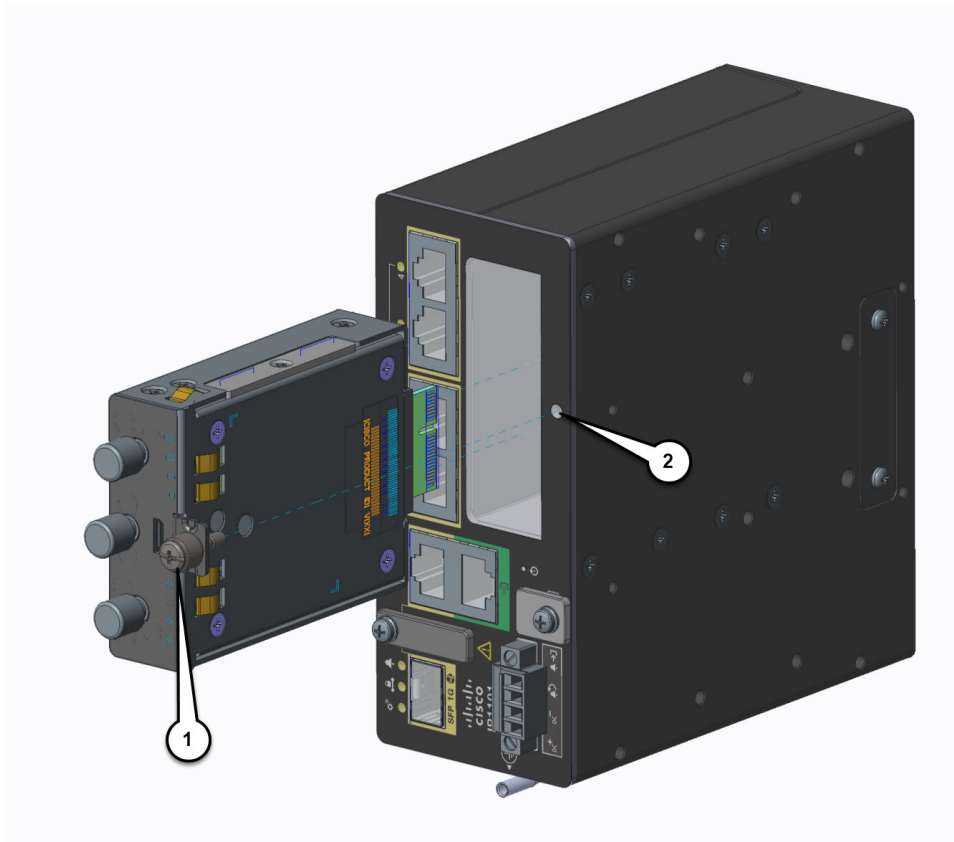

Step 9 Attach your antennas to the ports on the pluggable module. There are different instructions for each antenna type, be sure to consult the antenna documentation for proper orientation and torque to install them.

Step 10 If no antennas are being installed on a port, make sure the caps are installed on the connector.



CHAPTER 4

Antenna Selection and Installation

This chapter contains the following sections:

- [Antenna Selection and Installation, on page 45](#)

Antenna Selection and Installation

NOTE: Before you install the Cisco IR1101 Integrated Services Router on a table, wall, or DIN rail, install the antennas on the Pluggable Module. It is difficult to install the antennas after the router is installed.

The following section contains information for installing antennas with the base IR1101 router with or without the Expansion Modules, using P-LTE-xx or P-LTEA-xx cellular modules. There are three RF SMA(f) connectors on the Pluggable Module. Two connectors, Main and Div (diversity) are used to connect to the 4G/LTE modem. The third connector is used for GPS. The Diversity port may also be referred to as an Aux connector.

Antenna Installation Best Practices

The optimal site location for antennas for 4G routers and cellular modules plays a significant role in determining overall cellular link performance. Routers located at the farthest coverage points might have 10 to 50 percent of the bandwidth available compared to routers located closer to the cellular base station tower, away from obstructions, and with an unobstructed view of the cellular tower.

Because antennas transmit and receive radio signals over the air, the signal propagation and antenna performance may be adversely affected by the surrounding environment, including physical obstructions. Radio frequency (RF) interference may also occur between wireless systems located close to each other, especially if the antennas of these systems are located close to each other. Interference may also occur when the antenna is in close proximity to cable clutter or other sources of radio interference.

Follow these guidelines to ensure the best possible performance:

- When you use any cellular antennas such as 3G UMTS, 4G/LTE, 4G/LTEA (LTE Advanced) with a modular router and a pluggable module, try to mount the antenna a certain distance away from the router. For example, in indoor deployments, an appropriate extension cable and antenna stand can be utilized. For outdoor installations, choose a suitable outdoor antenna, and mount it away from obstructions that ideally have a direct view of the cellular tower. The antenna performance, and therefore that of the router, will not be optimal if mounted directly on a pluggable module. Primary reasons for possible degradation of performance include:

- Obstruction of the router antenna view of the cellular base station tower by Ethernet cables, power cables, USB cables, and walls.
- Possible coupling of digital noise from inside the router to the antenna when unshielded Ethernet cables are used.
- Keep antennas away from electrical and signal cable clutter. Metal conductors inside cables may block antenna view of the base station. Additionally, unshielded (and even shielded cables in some cases) may radiate signals that interfere with RF signal reception.
- It is recommended that all cellular antennas for the IR1101 are oriented vertically to ensure polarization match. While polarization of the signal may change as it is reflected from obstructions, when the view is unobstructed - vertical polarization is optimal.
- When installing the IR1101 with or without the Expansion Modules, the following note is important:

Note: When cellular FDD Band 5 is deployed with 3G WCDMA, 4G/LTE or 4G/LTEA C/A, such as with P-LTE-US or P-LTEA-EA pluggable modules on certain carriers, ensure that both Main and Aux cellular antennas are physically separated from the IR1101 chassis by a minimum of 5 feet (1.5 meters). This note only affects P-LTE-xx receiver operation in Band 5 in a narrow 875 MHz frequency range. No significant effect on the P-LTE-xx cellular Band 5 receiver has been measured when antennas are separated from the chassis by more than 5 feet (1.5 meters). This note does not apply when the receive signal does not overlap 875 MHz, such as when operating on other bands, or other frequencies within FDD Band 5.

- For optimal MIMO performance, space cellular Main and Aux antennas apart by at least 17 inches (43 cm). At the lowest LTE frequency of 700 MHz, 17 inches represents 1 wavelength. Spacing of half (or 0.5) wavelength or 8.5 inch (22.5cm) results in good MIMO performance.
- Spacing Main and Aux LTE antennas less than 8.5 inches may result in significantly reduced MIMO performance.
- Spacing antennas too close to each other (e.g. 3 inches) results in antennas significantly detuning from their original designed performance due to antenna coupling.
- Wherever possible, mount the IR1101 router with the pluggable LTE module and antenna where the cellular base station or tower are within sight and without physical obstructions. Barriers along the line of sight between the router and the local base station will degrade the wireless radio signals. Install the IR1101, pluggable modules and antennas above floor level in office environments or near the ceiling for better performance because most obstructions tend to be near the floor level.
- The density of the materials used in a building's construction determines the number of walls the signal must pass through while still maintaining adequate coverage. Consider the following before choosing the location for installing the antenna:
 - Paper and vinyl walls have very little effect on signal penetration.
 - Solid and precast concrete walls limit signal penetration to one or two walls without degradation of coverage.
 - Concrete and wood block walls limit signal penetration to three or four walls.
 - A signal can penetrate five or six walls constructed of drywall or wood.
 - A thick metal wall or wire-mesh stucco wall causes signals to reflect back and causes poor penetration.
- Avoid mounting the antenna next to a column or vertical support that could create a shadow zone and reduce the coverage area.
- Keep the antenna away from reflective metal objects such as heating and air-conditioning ducts, large ceiling trusses, building superstructures, and major power cabling runs. If necessary, use an extension cable to relocate the antenna away from these obstructions.

Supported Antennas for the IR1101

All of the currently supported antennas are broken down by functional groups.

Cellular 2G/3G/4G Antennas

Part Number/ Description	RF Connectors	Antenna Frequency Band Support and Gain
<p>Cisco Cellular and GPS 3-in-1 Vehicle Mount and Fixed Infrastructure Antenna (ANT-3-4G2G1-O).</p> <p>Fixed Infrastructure Antenna with three ports; two port 2G/3G/4G and one port GPS Vehicle Mount.</p>	<p>2 x 4G/LTE, TNC(m)</p> <p>1 x GPS SMA(m)</p>	<p>4G/LTE 698-960, 1448-1511, 1710-2400, 2500-2700 MHz</p> <p>2.6 dBi typical, 3.8 dBi max 698-960 MHz</p> <p>3.8 dBi typical, 4.3 dBi max 1448-1551 MHz</p> <p>4.6 dBi typical, 5.5 dBi max 1710-2700 MHz</p>
<p>Cisco Dual LTE-Single GPS Multi-band Antenna (4G-LTE-ANTM-O-3-B).</p> <p>Integrated indoor and outdoor Antenna with three ports; two ports for 2G, 3G, 4G/LTE and one port for GPS.</p>	<p>2 x 4G/LTE, SMA(m)</p> <p>1 x GPS SMA(m)</p>	<p>4G/LTE 698-960, 1710-2700 MHz</p> <p>2.5 dBi typical 698-960 MHz</p> <p>2.5 dBi typical 1710-2700 MHz</p>
<p>Cisco Cellular 2-in-1 Vehicle Mount and Fixed Infrastructure Antenna (ANT-2-4G2-O).</p> <p>Two port 2G/3G/4G antenna with two elements.</p> <p>This dual port LTE antenna does not have an active GPS antenna (compared to ANT-3-4G2G1-O which does), and is useful for cases when there is no GPS required, or when GPS is connected to a completely separate GPS antenna.</p>	<p>2 x 4G/LTE, TNC(m)</p>	<p>4G/LTE: 698-960,1448-1511,1710-2400,2500-2700 MHz</p> <p>2.6 dBi typical, 3.8 dBi max 698-960 MHz</p> <p>3.8 dBi typical, 4.3 dBi max 1448-1511 MHz</p> <p>4.6 dBi typical, 5.5 dBi max 1710-2700 MHz</p> <p>No GPS element and no WiFi.</p>
<p>Cisco Outdoor Omnidirectional Antenna for 2G/3G/4G Cellular (ANT-4G-OMNI-OUT-N).</p> <p>Outdoor Omnidirectional Antenna for 2G/3G/4G Cellular antenna is designed to cover domestic LTE700/Cellular/PCS/AWS/MDS, WiMAX 2300/2500, and GSM900/GSM1800/UMTS/LTE2600 bands.</p>	<p>N(f)</p>	<p>1.5 dBi 698-960 MHz</p> <p>2 dBi 1448-1511 MHz</p> <p>3.5 dBi 1710-2700 MHz</p>

Part Number/ Description	RF Connectors	Antenna Frequency Band Support and Gain
<p>Cisco Multiband Panel Outdoor 4G MIMO Antenna (ANT-4G-PNL-OUT-N).</p> <p>Multiband Panel Outdoor 4G MIMO dual-port antenna designed to cover cellular 4G bands.</p>	Dual type N female direct connector	<p>698-960 MHz 8.0-10.0 dBi</p> <p>1710-2170 MHz 6.0-8.5 dBi</p> <p>2200-2400 MHz 6.5-9.5 dBi</p> <p>2500-2700 MHz 8.5-9.5 dBi</p> <p>Antenna is not designed to operate in 1448-1511 MHz Japan band. Does not have high gain.</p>
<p>Cisco 4G/LTEA, 4G/LTE, and 3G Omnidirectional Dipole Antenna (LTE-ANTM-SMA-D).</p> <p>LTE-ANTM-SMA-D is a high performance indoor antenna for use in the 698-960, 1448-1511 and 1710-2690 MHz frequency bands.</p> <p>LTE-ANTM-SMA-D antennas have high standalone efficiency, and maintain high efficiency when directly installed on front plate of a small or medium size Cisco router. However, depending on chassis size and a variety of other electromagnetic considerations, installing the antenna directly on the chassis is not always recommended.</p>	1 x SMA(m)	<p>2 dBi, 698-960 MHz</p> <p>2.8 dBi, 1447-1511 MHz</p> <p>3.7 dBi, 1710-2690 MHz</p>

GPS Antennas

Part Number / Description	RF Connectors	Antenna Frequency Band Support and Gain
<p>Cisco GPS Antenna (ANT-GPS-OUT-TNC).</p> <p>Active GPS antenna, integrated 15' LMR-100 cable with RA-TNC(m).</p> <p>The ANT-GPS-OUT-TNC integrated GPS RF front end is designed to reject collocated RF interference.</p>	Right-angle TNC(m)	Active GPS antenna, 4.0 dBi min at Zenith, 1575.42 MHz, plus 25 dB amplifier gain
<p>Cisco Indoor/Outdoor Active GPS Antenna (GPS-ACT-ANTM-SMA).</p> <p>Active GPS antenna that can be physically connected to the Cisco Integrated Services Routers (ISRs) and Cisco Enhanced High-Speed WAN Interface Cards (EHWICs) to receive GPS broadcasts from satellites.</p> <p>GPS-ACT-ANTM-SMA has GPS filters, but all the filters are after the LNA. Therefore, antenna may not be suitable for co-location with strong RF transmitters.</p>	SMA(m)	Active GPS antenna, 4 dBi @Zenith, 1575.42 MHz, plus 27 dB amplifier gain

Part Number / Description	RF Connectors	Antenna Frequency Band Support and Gain
<p>Cisco Dual LTE-Single GPS Multi-band Antenna (4G-LTE-ANTM-O-3-B).</p> <p>Integrated indoor and outdoor Antenna with three ports; two ports for 2G, 3G, 4G/LTE and one port for GPS.</p> <p>The 4G-LTE-ANTM-O-3-B integrated GPS RF front end is designed to reject collocated RF interference.</p>	<p>2 x 4G/LTE, SMA(m)</p> <p>1 x GPS SMA(m)</p>	<p>2.5 dBi typical 698-960 MHz</p> <p>2.5 dBi typical 1710-2700 MHz</p> <p>One port with GPS element.</p>

Supported RF Cables for the IR1101

The following tables provide information for the cables supported by the IR1101:

- [Table 13: N\(m\) to N\(m\) RF cables, on page 49](#)
- [Table 14: N\(m\) to TNC\(m\) RF cable, on page 50](#)
- [Table 15: TNC\(m\) to TNC\(f\) RF cable, on page 50](#)
- [Table 16: TNC\(m\) to SMA\(m\) RF cables, on page 50](#)

Table 13: N(m) to N(m) RF cables

Antenna Cable Type	Description	RF Loss
AIR-CAB002L240-N	N(m)-STR to N(m)-RALMR-240, 2 foot RF cable Type: Indoor Interconnect. Not DB, CMR or CMP (not direct burial or flame rated)	0.2 dB @ 0.7 GHz 0.3 dB @ 1.0 GHz 0.4 dB @ 1.7 GHz 0.5 dB @ 2.4 GHz 0.8 dB @ 5.8 GHz
AIR-CAB005LL-N	N(m)-STR to N(m)-RALMR-400, 5 foot RF cable Type: outdoor DB (direct burial)	0.2 dB @ 0.7 GHz 0.3 dB @ 1.0 GHz 0.4 dB @ 1.7 GHz 0.5 dB @ 2.4 GHz 0.8 dB @ 5.8 GHz
CAB-L400-5-N-N	N(m)-STR to N(m)-RALMR-400, 5 foot RF cable Type: outdoor DB (direct burial)	0.2 dB @ 0.7 GHz 0.3 dB @ 1.0 GHz 0.4 dB @ 1.7 GHz 0.5 dB @ 2.4 GHz 0.8 dB @ 5.8 GHz
CAB-L400-5-N-NS	N(m)-STR to N(m)-STR LMR-400, 5 foot RF cable Type: outdoor DB (direct burial)	0.2 dB @ 0.7 GHz 0.3 dB @ 1.0 GHz 0.4 dB @ 1.7 GHz 0.5 dB @ 2.4 GHz 0.8 dB @ 5.8 GHz
AIR-CAB010LL-N	N(m)-STR to N(m)-RALMR-400, 10 foot RF cable Type: outdoor DB (direct burial)	0.4 dB @ 0.7 GHz 0.5 dB @ 1.0 GHz 0.7 dB @ 1.7 GHz 0.9 dB @ 2.4 GHz 1.5 dB @ 5.8 GHz
CAB-L400-20-N-N	N(m)-STR to N(m)-RALMR-400, 20 foot RF cable Type: outdoor DB (direct burial)	0.8 dB @ 0.7 GHz 1.0 dB @ 1.0 GHz 1.3 dB @ 1.7 GHz 1.6 dB @ 2.4 GHz 2.5 dB @ 5.8 GHz
AIR-CAB025HZ-N	N(m)-STR to N(m)-STR LMR-400, 25 foot RF cable Type: outdoor DB (direct burial) with additional resistance to petrochemicals and oils	1.0 dB @ 0.7 GHz 1.2 dB @ 1.0 GHz 1.6 dB @ 1.7 GHz 2.0 dB @ 2.4 GHz 3.1 dB @ 5.8 GHz
CAB-L600-30-N-N	N(m)-STR to N(m)-RALMR-600, 30 foot RF cable Type: outdoor DB (direct burial)	0.8 dB @ 0.7 GHz 0.9 dB @ 1.0 GHz 1.3 dB @ 1.7 GHz 1.6 dB @ 2.4 GHz 2.6 dB @ 5.8 GHz

Table 14: N(m) to TNC(m) RF cable

Antenna Cable Type	Description	RF Loss
CAB-L400-20-TNC-N	TNC(m)-RA to N(m)-STRLMR-400, 20 foot RF cable Type: outdoor DB (direct burial)	0.8 dB @ 0.7 GHz 1.0 dB @ 1.0 GHz 1.3 dB @ 1.7 GHz 1.6 dB @ 2.4 GHz
CAB-L400-50-TNC-N	TNC(m)-RA to N(m)-STRLMR-400, 50 foot RF cable Type: outdoor DB (direct burial)	1.9 dB @ 0.7 GHz 2.3 dB @ 1.0 GHz 3.1 dB @ 1.7 GHz 3.8 dB @ 2.4 GHz

Table 15: TNC(m) to TNC(f) RF cable

Antenna Cable Type	Description	RF Loss
4G-CAB-LMR400-10	TNC(m)-RA to TNC(f)-STRLMR-400, 10 foot RF cable Type: outdoor DB (direct burial)	0.4 dB @ 0.7 GHz 0.5 dB @ 1.0 GHz 0.7 dB @ 1.7 GHz 0.8 dB @ 2.4 GHz
4G-CAB-ULL-20	TNC(m)-RA to TNC(f)-STRLMR-400, 20 foot RF cable Type: Plenum	0.8 dB @ 0.7 GHz 1.0 dB @ 1.0 GHz 1.3 dB @ 1.7 GHz 1.6 dB @ 2.4 GHz
4G-CAB-LMR240-25	TNC(m)-RA to TNC(f)-STRLMR-240, 25 foot RF cable Type: Plenum	1.9 dB @ 0.7 GHz 2.3 dB @ 1.0 GHz 3.0 dB @ 1.7 GHz 3.6 dB @ 2.4 GHz
4G-CAB-LMR240-50	TNC(m)-RA to TNC(f)-STRLMR-240, 50 foot RF cable Type: Plenum Note: The cable is not recommended for longer distance links due to high loss of 50 foot LMR240 at most cellular frequencies. The customer may need to do a site survey to validate whether the cable allows sufficient signal-to-noise ratio to or from cell tower.	3.7 dB @ 0.7 GHz 4.5 dB @ 1.0 GHz 5.9 dB @ 1.7 GHz 7.2 dB @ 2.4 GHz
4G-CAB-ULL-50	TNC(m)-RA to TNC(f)-STRLMR-400, 50 foot RF cable Type: Plenum	1.9 dB @ 0.7 GHz 2.3 dB @ 1.0 GHz 3.1 dB @ 1.7 GHz 3.8 dB @ 2.4 GHz
4G-CAB-LMR240-75	TNC(m)-RA to TNC(f)-STRLMR-240, 75 foot RF cable Type: Plenum Note: The cable is not recommended for high throughput or longer distance links due to high loss of 75 foot LMR240 at most cellular frequencies. The customer may need to do a site survey to validate whether the cable allows sufficient signal-to-noise ratio to or from cell tower.	5.5 dB @ 0.7 GHz 6.7 dB @ 1.0 GHz 8.8 dB @ 1.7 GHz 10.7 dB @ 2.4 GHz

Table 16: TNC(m) to SMA(m) RF cables

Antenna Cable Type	Description	RF Loss
CAB-L240-10-SM-TM	SMA(m)-STR to TNC(m)-STRLMR-240, 10ft RF cable Type: outdoor DB (direct burial)	0.8 dB @ 0.7 GHz 0.9 dB @ 1.0 GHz 1.2 dB @ 1.7 GHz 1.5 dB @ 2.4 GHz 1.6 dB @ 2.7 GHz
CAB-L240-15-SM-TM	SMA(m)-STR to TNC(m)-STRLMR-240, 15ft RF cable Type: outdoor DB (direct burial)	1.1 dB @ 0.7 GHz 1.4 dB @ 1.0 GHz 1.8 dB @ 1.7 GHz 2.2 dB @ 2.4 GHz 2.3 dB @ 2.7 GHz
CAB-L240-20-SM-TM	SMA(m)-STR to TNC(m)-STRLMR-240, 20ft RF cable Type: outdoor DB (direct burial)	1.5 dB @ 0.7 GHz 1.8 dB @ 1.0 GHz 2.4 dB @ 1.7 GHz 2.9 dB @ 2.4 GHz 3.1 dB @ 2.7 GHz

Cellular Antenna Extension Bases

The following table provide information for the Extension Bases supported by the IR1101.

Table 17: Extension Bases

Extension Base PID	Description	RF Loss
4G-AE010-R	TNC(m)-STR to TNC(f)-STR LMR-195, 10 foot RF cable Type: Plenum Antenna extension bases	1.1 dB @ 0.7 GHz 1.4 dB @ 1.0 GHz 1.8 dB @ 1.7 GHz 2.1 dB @ 2.4 GHz 2.3 dB @ 2.7 GHz
4G-AE015-R	TNC(m)-STR to TNC(f)-STR LMR-195, 15 foot RF cable Type: Plenum Antenna extension bases	1.7 dB @ 0.7 GHz 2.0 dB @ 1.0 GHz 2.6 dB @ 1.7 GHz 3.2 dB @ 2.4 GHz 3.4 dB @ 2.7 GHz
LTE-AE-MAG-SMA	TNC(f)-STR to SMA(f)-STR LMR-195, 1ft RF cable Type: Plenum Antenna extension bases	0.2 dB @ 0.7 GHz 0.2 dB @ 1.0 GHz 0.3 dB @ 1.7 GHz 0.3 dB @ 2.4 GHz 0.3 dB @ 2.7 GHz

Accessories

The following table provides information for other accessories supported by the IR1101:

- [Table 18: Cisco Lightning Arrestors, on page 51](#)
- [Table 19: Cisco Coaxial Adapters, on page 51](#)

Table 18: Cisco Lightning Arrestors

Cisco PID	Connectors Type	Arrestor Type and Frequency Range (MHz)
CGR-LA-NM-NF	N(m)-STR to N(f)-STR	DC to 6000 MHz GDT type Supports active GNSS antennas, passes DC
ACC-LA-H-NM-NF	N(m)-STR to N(f)-STR	698 to 2700 MHz High power, ultra low shunt impedance, HPF type Does not pass DC, no support for active GNSS antennas
CGR-LA-NF-NF	N(f)-STR to N(f)-STR	DC to 6000 MHz GDT type Supports active GNSS antennas, passes DC
ACC-LA-G-TM-TF	TNC(f)-STR to TNC(m)-STR	DC to 6000 MHz GDT type Supports active GNSS antennas, passes DC
ACC-LA-G-TF-TF	TNC(f)-STR to TNC(f)-STR	DC to 6000 MHz GDT type Supports active GNSS antennas, passes DC

Table 19: Cisco Coaxial Adapters

Cisco PID	Connectors Type
AIR-ACC370-NF-NF	N(f)-STR to N(f)-STR
LTE-ADPT-SM-TF	SMA(m)-STR to TNC(f)-STR



CHAPTER 5

Installing the IRM-1100 Expansion Module

This chapter describes the equipment and the procedures for successfully installing the Cisco IRM-1100 Expansion Module onto the IR1101, and contains the following sections:

- [Installing the IRM-1100 Expansion Module, on page 53](#)

Installing the IRM-1100 Expansion Module

This chapter describes the equipment, and the procedures for successfully installing the Cisco IRM-1100 Expansion Module onto the IR1101. There are two different Expansion Modules available:

- IRM-1100-SPMI
- IRM-1100-SP

Details on both Expansion Modules can be found in the Product Overview chapter.

This chapter contains the following sections:

Items Shipped with your Expansion Module

Unpack the box and verify that all items listed on the invoice were shipped with the Cisco IRM-1100.

The following items are shipped with your Expansion Module:

- 4 mating screws to connect the IRM-1100 to the IR1101

Installing the Expansion Module

This section describes how to install the Cisco IRM-1100. The Expansion Module attaches to the IR1101 ISR using 4 mating screws, and is connected through a mating connector. The Expansion Module is grounded and powered through the connection to the IR1101.

To attach the IRM-1100 to the IR1101, perform the following steps:

-
- Step 1** Remove the protective cover from the mating connector on the IR1101 by unscrewing the two Phillips head screws. Refer to [Figure 27: Protective Cover, on page 54](#).

Figure 27: Protective Cover



- Step 2** After removing the protective connector cover from the IR1101, carefully align the Expansion Module to the IR1101 so that both mating connectors engage. See [Figure 28: Mounting the Expansion Module, on page 55](#). Once properly seated, install the four mating screws to fully secure the Expansion Module to the IR1101.

Figure 28: Mounting the Expansion Module

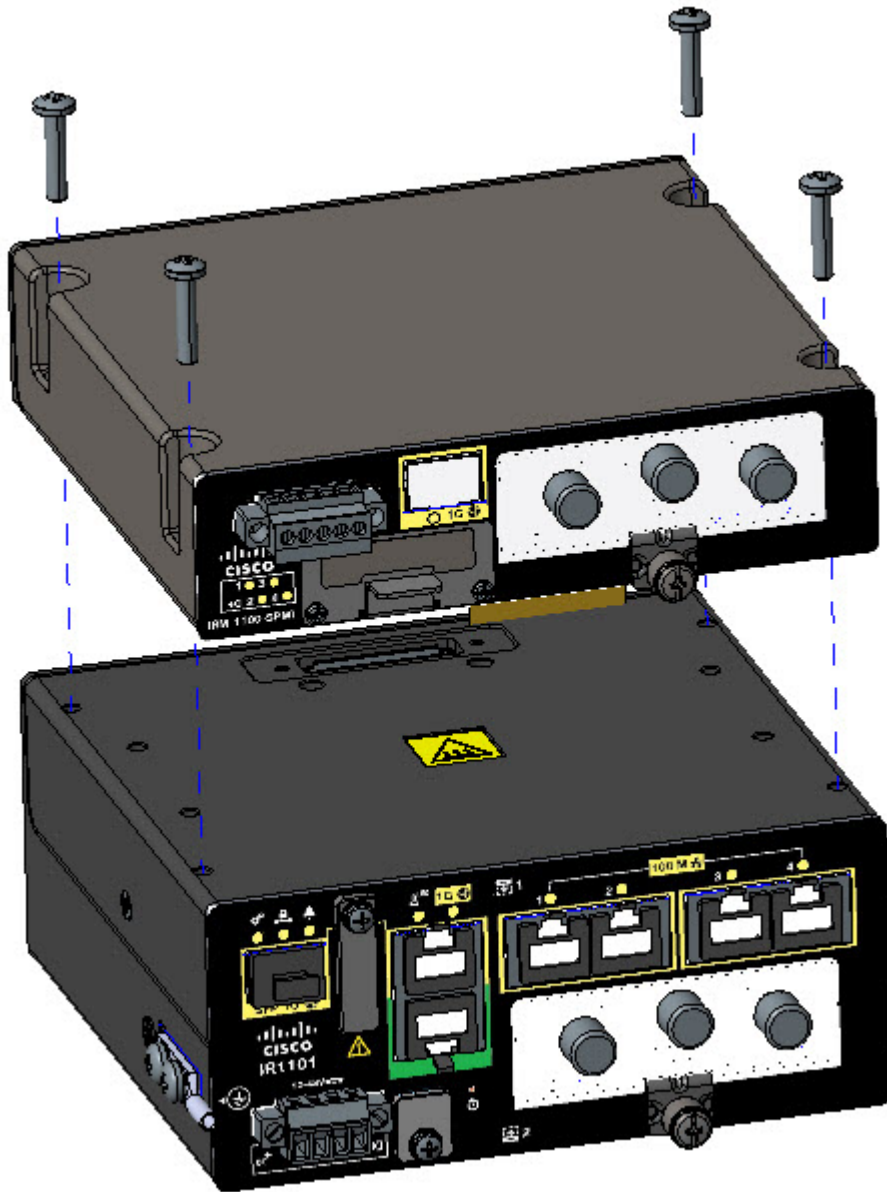

- Step 3** Tighten the screws to a torque of 13-15 in. lbs (1.5-1.7 newton meter). When complete, the two devices form a single assembly as shown in [Figure 29: Completed Assembly, on page 56](#).

Figure 29: Completed Assembly



Mounting the IR1101 Router with the IRM-1100 Expansion Module Attached

After the Cisco IRM-1100 is attached to the IR1101, it can be mounted in the following ways:

- On a DIN Rail
- Using mounting brackets

Note: For the remainder of these instructions, we will refer to the combined IR1101/IRM-1100 as the “Device”.

Mounting the Device Using Mounting Brackets

TIP: When choosing a location for wall-mounting the Device, consider cable limitations and wall structure.

WARNING: Read the wall-mounting instructions carefully before beginning installation. Failure to use the correct hardware or to follow the correct procedures could result in a hazardous situation to people and damage to the system. **Statement 378**

WARNING: A minimum of 1 inch clearance is required on all sides of the Device when mounting to allow for proper air flow.

The wall mounting kit contains the following:

- Mounting brackets (x2)
- Mounting screws (x4)

The Device can be mounted on the top of a flat surface as shown in [Figure 30: Table Mounting, on page 57](#), but cannot be mounted upside down.

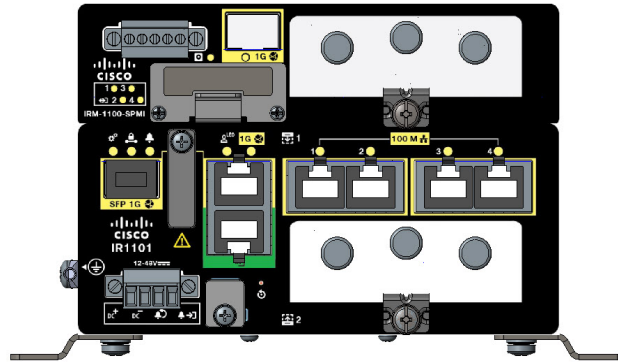
Figure 30: Table Mounting

The device can also be mounted vertically on a wall in 4 orientations as shown in [Figure 31: Wall Mounting](#), on page 57.

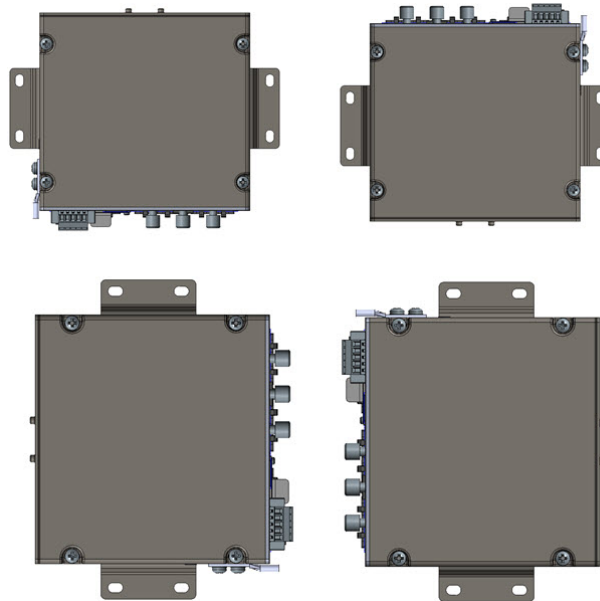
Figure 31: Wall Mounting

To mount the Device on a wall or other flat surface, follow these steps:

-
- Step 1** Attach the mounting brackets to the bottom of the Device. Refer to [Figure 32: Mounting Brackets](#), on page 58 for guidance.

Figure 32: Mounting Brackets

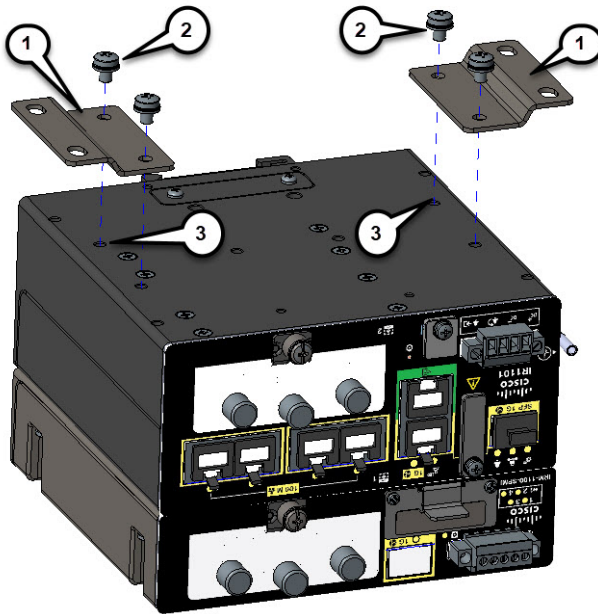

- Step 2** Align the mounting brackets (1) over the mounting holes (3) so that the larger holes on the brackets extend out over the Device.
- Step 3** Attach the brackets to the Device with the 4 screws (2) provided using a Phillips head driver. Torque to 13-15 in. lbs (1.5-1.7 newton meter).
- Step 4** Mount the Device with the attached brackets in a proper wall structure to carry the weight of the device, which is a combined 3.85 lbs. See [Figure 33: Wall/Floor mounting hole dimensions with mounting brackets attached, on page 59](#) and [Figure 34: Wall/Floor mounting clearance and overall dimensions with mounting brackets attached, on page 60](#) for the dimensions of the mounting holes with the brackets attached to the Device.

Figure 33: Wall/Floor mounting hole dimensions with mounting brackets attached

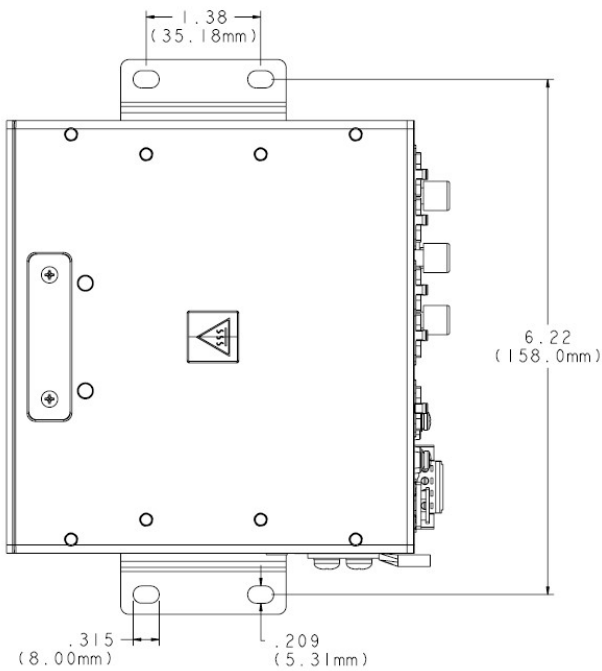

Note: Four #10-32 screws are recommended when mounting the Device with these brackets attached to the neighboring surface.

Figure 34: Wall/Floor mounting clearance and overall dimensions with mounting brackets attached

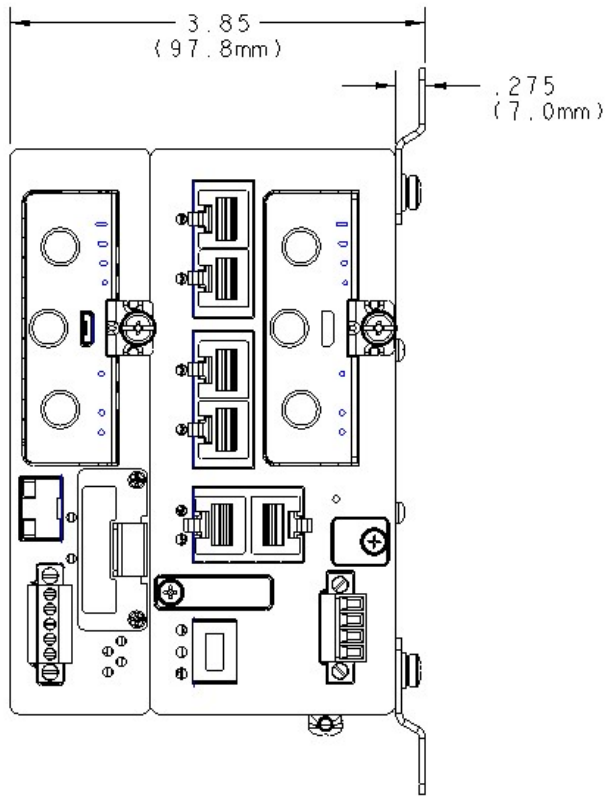

Step 5 Route the cables so that they do not put a strain on the connectors or mounting hardware.

Installing a DIN Rail

The DIN Rail kit is ordered separately. The Device can only be mounted vertically, with the ground lug on the bottom side as shown in [Installing a DIN Rail, on page 60](#).

Figure 35: Device Orientation

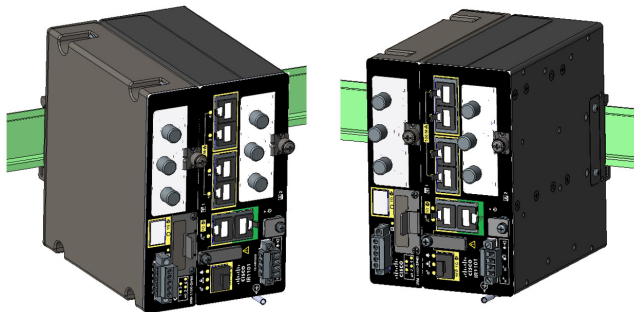

Mounting the DIN Rail Bracket on the Device

- Step 1** First, attach the DIN rail brackets to the back of the Device. There are two separate mounting brackets. One attaches to the IR1101, and the other attaches to the IRM-1100. The combined DIN rail brackets mount in the vertical orientation only. See [Figure 36: Attaching the DIN Rail Brackets, on page 61](#).

Figure 36: Attaching the DIN Rail Brackets

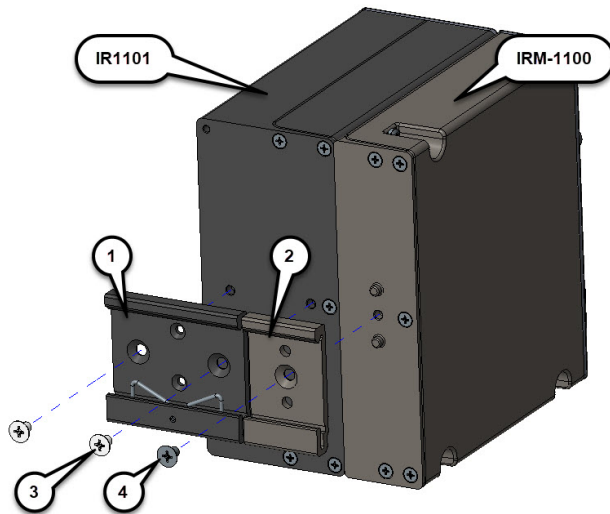

- Step 2** Attach the IR1101 DIN mounting bracket (1) to the Device using the two screws (3) provided in the kit. Position the bracket over the two mounting holes, then use 13-15 in. lbs. (1.5-1.7 newton meter) of torque to screw the bracket onto the Device.
- Step 3** Attach the IRM-1100 DIN mounting bracket (2) to the Device using the screw (4) provided in the kit. Position the bracket over the single mounting hole, then use 13-15 in. lbs. (1.5-1.7 newton meter) of torque to screw the bracket onto the Device.
- Step 4** Once the two brackets are attached to the Device, it can be mounted onto the DIN Rail.

Attaching the Bracket Onto the DIN Rail

To attach the Device with the brackets to a DIN rail, follow these steps. Refer to [Figure 37: Attaching the Brackets to the DIN Rail, on page 62](#) for details.

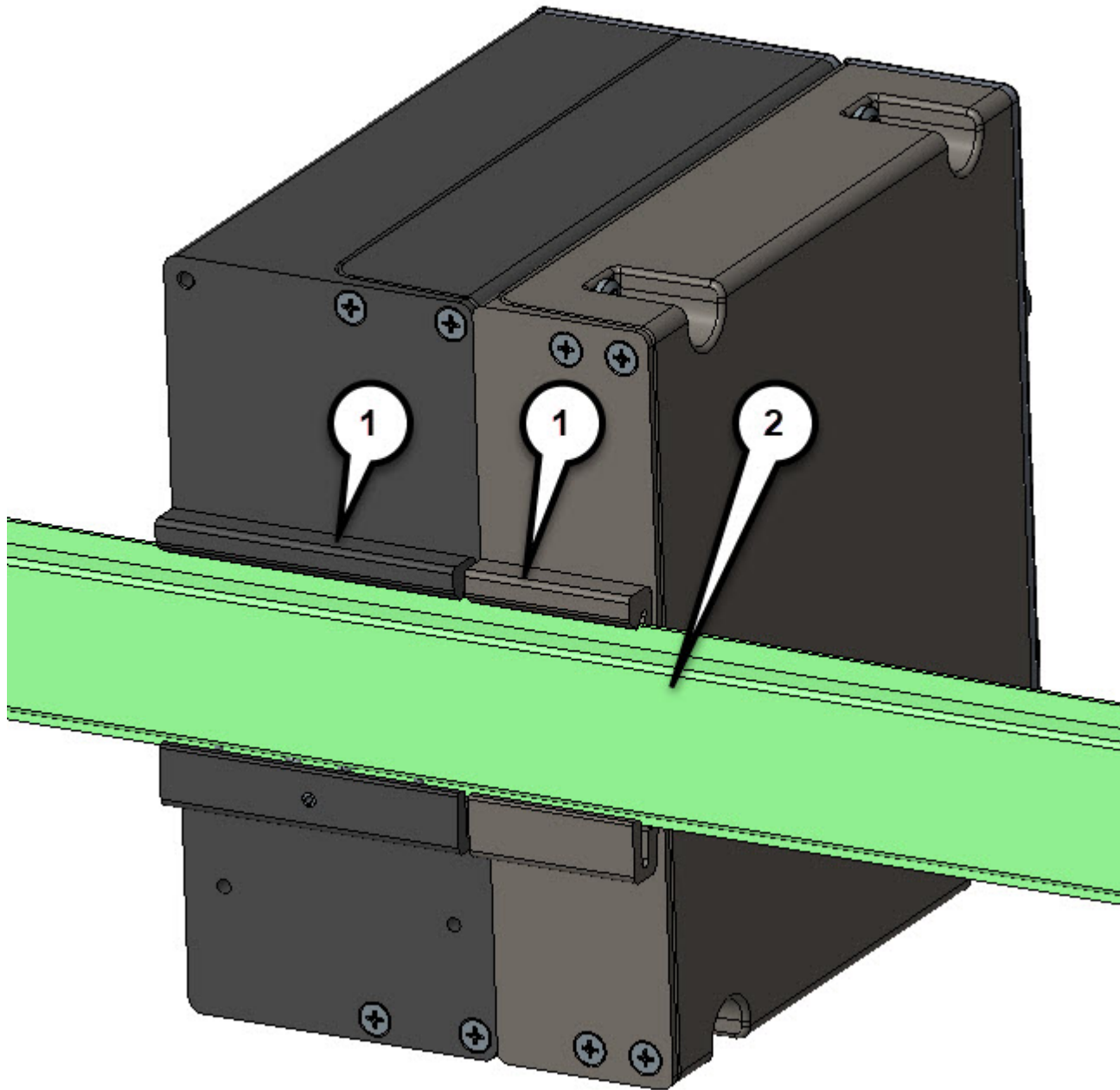
Figure 37: Attaching the Brackets to the DIN Rail

-
- Step 1** Position the Device so that the lower edge and spring of the Din clips (1) engages with the bottom section of the Din rail (2).
- Step 2** Push up on the Device so that the spring of DIN clips (1) compresses against the lower section of DIN rail (2) and then rotate the Device so that the top hook of the DIN clips (1) clamps to the top section of DIN rail (2).
- Step 3** To remove the Device from the DIN Rail, simply reverse the procedure.

NOTE: In order to prevent excessive side to side movement of the unit it is advised to install DIN rail stop plates such as Mouser part Numbers 653-PFP-M, 651-1201662 or 845-CA402. These stop plates can be installed on one or both sides of the unit to limit excessive side to side movement that typically occurs in high vibration environments.

Step 4 If you are using this Device in a vehicle, attach the ring terminal to the chassis using one of the screws provided and the green or green and yellow striped wire. Connect the other end of the wire to the vehicle ground.

What to do next

After you install and properly ground the Device, you can connect the power wiring, the LAN cables, and the cables for administrative access as required for your installation.

Pluggable Module

The Pluggable Module provides the IRM-1100 with a number of different configuration options. The installation of the Pluggable Module into the Expansion Module is the same as installing it into the IR1101. See that section at [Pluggable Module, on page 39](#).

Digital I/O Connections

The wired Digital I/O connector is show as **(1)** in [Digital I/O Connector, on page 15](#).

Figure 38: Digital I/O connector

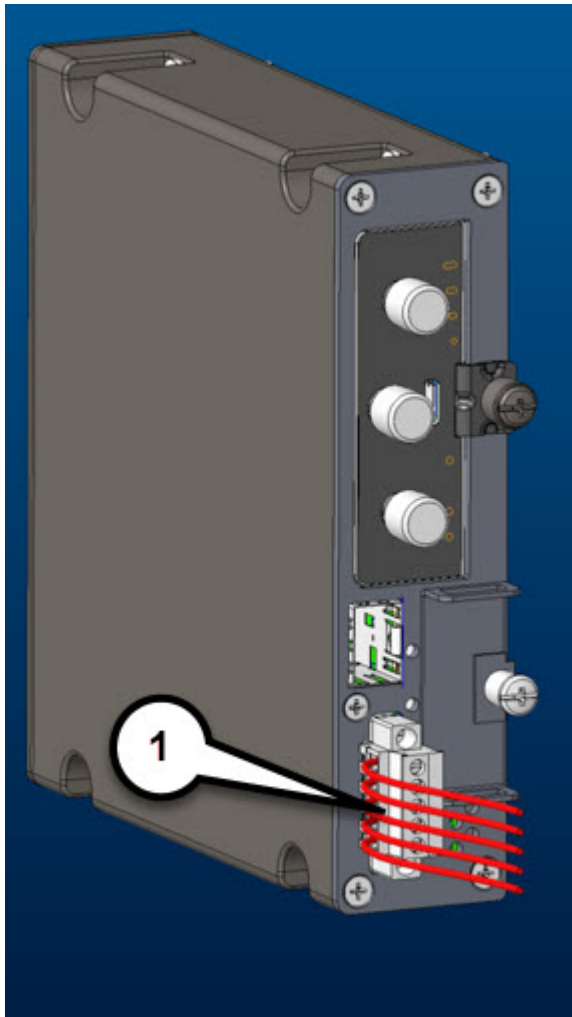

The Digital I/O connector has 4 GPIO connections plus 1 Return connection. The default state of the Digital I/O is input, the open-collector is open (off). Further details on the Digital I/O connector can be found at [Digital I/O Connector, on page 15](#).

Wiring the Alarm Connections

To wire the alarm connections on your Cisco IR1101 Expansion Module, follow these steps:

-
- Step 1** Locate the alarm connector on the router front panel.
 - Step 2** Identify the connectors.
 - Step 3** Using a wire-stripping tool, strip each of the alarm wires to 0.25 inch (6.3 mm) \pm 0.02 inch (0.5 mm). Do not strip more than 0.27 inch (6.8 mm) of insulation from the wire. Stripping more than the recommended amount of wire can leave exposed wire from the connector after installation.
 - Step 4** Remove the two captive screws that attach the alarm connector to the Expansion Module, and remove the connector

- Step 5** On the alarm connector, insert the exposed part of the wire into the connection. Make sure that you cannot see any wire lead. Only wire with insulation should extend from the connector. See [Figure 39: Alarm Connector Captive Screws](#), on page 65.

Figure 39: Alarm Connector Captive Screws

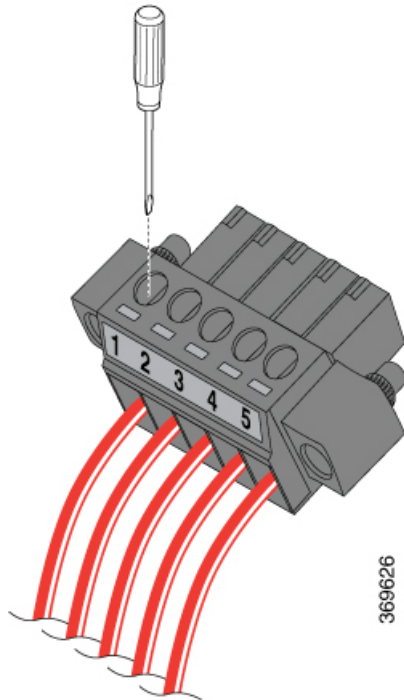

- Step 6** Use a ratcheting torque flathead screwdriver to torque the power connector captive screws (above the installed wire leads) to 2 in-lb (0.23 N-m).
- Step 7** Connect the other end of the wires to the alarm source, and re-attach the alarm connector to the Expansion Module.

Installing the mSATA SSD

Mini-SATA, or mSATA, is a low-profile interface connector that enables more effective Serial ATA (SATA) integration in small form-factor drives roughly the size of a business card, such as solid state disks (SSDs).

This section provides an overview of the mSATA SSD available for the Cisco IRM-1100 Expansion Module.

mSATA Installation Instructions

Note: Ensure that you are using proper static discharge techniques such as a wrist strap and static mat.

Caution: Ensure the device is powered down before performing any removal or installation of a module.

The mSATA SSD module plugs into the slot shown in [Figure 40: Cisco IRM-1100-SPMI Front Panel](#), on page 66.

Figure 40: Cisco IRM-1100-SPMI Front Panel

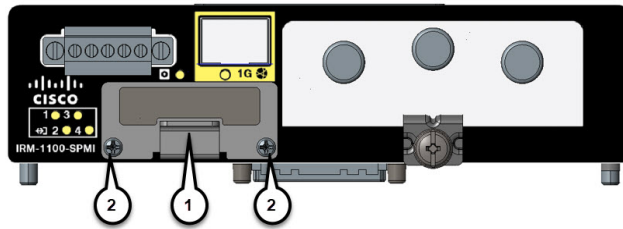

Item	Description
1	mSATA Module Slot
2	Module Captive Screws

Perform the following steps in order in install the module.

- Step 1** Remove the two screws (2) holding the cover of the mSATA Slot.
- Step 2** Insert the mSATA SSD module into the slot on the IRM-1100-SPMI. Refer to [Figure 41: Module Placement, on page 66](#) for guidance.

Figure 41: Module Placement

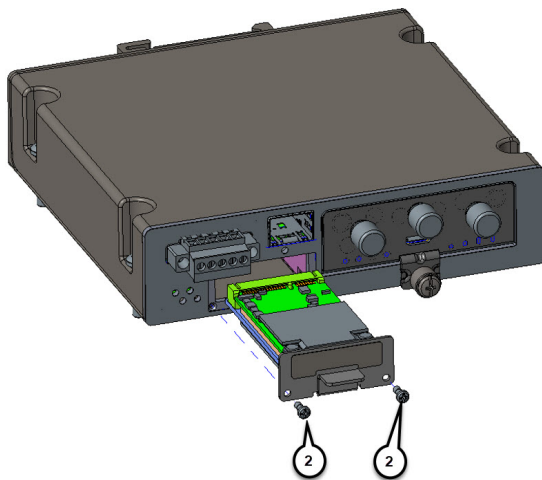

- Step 3** After the module is properly inserted, tighten the module plate to the IRM-1100-SPMI with the two screws (2). The screws should be torqued to 2-3 in-lb (0.2-0.3 newton meter).
- Step 4** The installation is now complete.



CHAPTER 6

Connecting the Router

This chapter describes how to connect the IR1101 to Ethernet devices and a network. The chapter contains the following sections:

- [Connecting the Router, on page 67](#)

Connecting the Router

This chapter describes how to connect the IR1101 to Ethernet devices and a network. The chapter contains the following sections:

Preparing to Connect the Router

Before you connect the router to the devices, install the router according to the instructions in [Installing the Router, on page 29](#) .

Preventing Damage to the Router

To prevent damage to your router, turn off power to the devices and to the router until all connections are completed.



Caution

Do not turn on the devices until after you have completed all connections to the router.

Connecting a PC, Server, or Workstation

To connect a PC (or other Ethernet devices) to an Ethernet switch port, follow these steps:

1. Connect one end of the Ethernet cable to an Ethernet switch port on the router.
2. Connect the other end of the cable to the RJ-45 port on the network interface card (NIC) that is installed in the PC, server, or workstation.
3. (Optional) Connect additional servers, PCs, or workstations to the other Ethernet switch ports.

Connecting a PC to the Console Port

Connect a PC to the Console port either to configure the software by using the CLI or to troubleshoot problems with the router. To connect a terminal or PC to the console port on the router and access the CLI, follow these steps:



Note On earlier models of the device, the console port speed was set at 115200. Later models had the console port speed switched to 9600.

Step 1 Connect the mini-USB console cable to the console port on the router. The following figure shows the console location on the router.

Figure 42: Console Connection

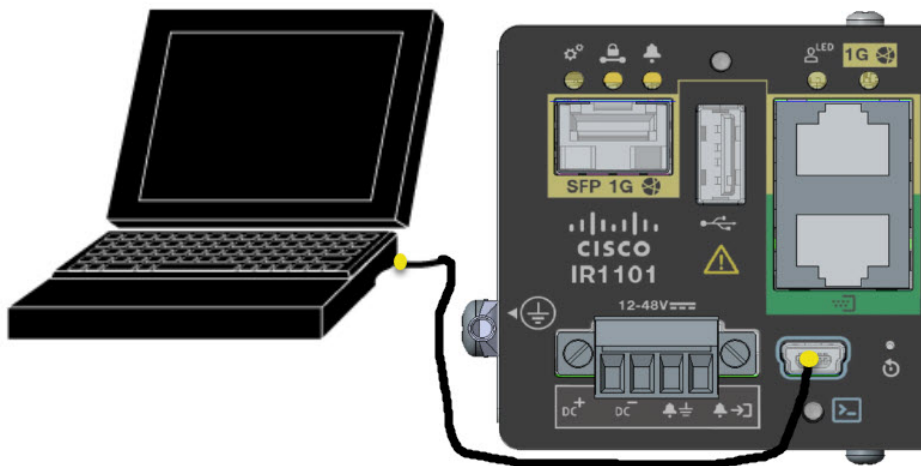

Step 2 Connect the opposite end of the mini-USB cable to the USB port on your laptop or PC.

Step 3 To communicate with the router, wait for your laptop or PC to discover the new device.

Step 4 If your laptop or PC warns you that you do not have the proper drivers to communicate with the router, you can obtain them from your computers manufacturer, or go here:

<https://www.silabs.com/products/mcu/Pages/USBtoUARTBridgeVCPDrivers.aspx>

Connecting to DC Power



Warning This product relies on the building's installation for short-circuit (overcurrent) protection. Ensure that the protective device is rated not greater than 60 VDC minimum, 5A maximum. **Statement 1005**

**Warning**

Connect the unit only to DC power source that complies with the safety extra-low voltage (SELV) requirements in IEC 60950 based safety standards. **Statement 1033**

**Warning**

This product requires short-circuit (overcurrent) protection, to be provided as part of the building installation. Install only in accordance with national and local wiring regulations. **Statement 1045**

Plugs and Pin-Outs

The IR1101 ships with a DC power accessory kit.

The power entry receptacle is on the IR1101. The pin-outs are shown in the following figure.

Figure 43: Power Connector Pin-outs

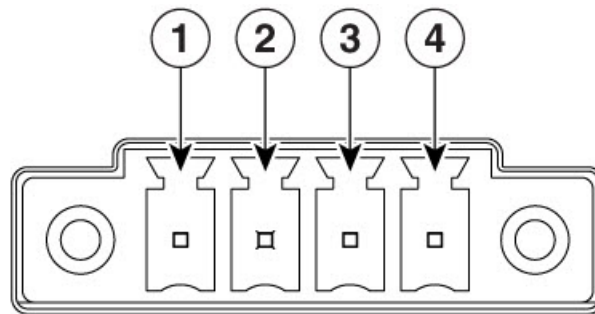



366912

Table 20: Power connector Descriptions

Pin Number	Name	Description
1	DC In +	DC Power Positive Input
2	DC In -	DC Power Return (GND-)
3	AC	Alarm Common
4	AI	Alarm Input

Wiring the DC Power

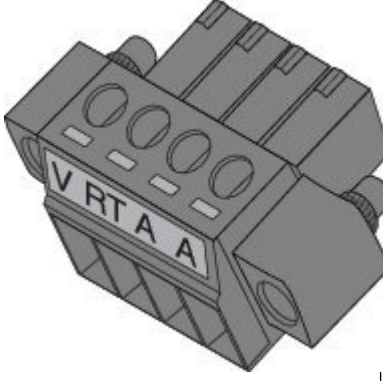
To connect the DC power on your Cisco IR1101, follow these steps:

1.	<p>Locate the power and alarm connector on the router front panel.</p> <p>NOTE: Your connector may not have the labels V RT A A.</p> <p>In the labeled connector, the pins are:</p> <p>V—Positive DC power connection RT—Return DC power connection A— Alarm Common A— Alarm Input</p>	
2.	<p>Identify the connector positive and return DC power connections. The connections left to right are:</p> <ul style="list-style-type: none"> • 1—Positive DC power connection • 2—Return DC power connection • 3—Alarm Common • 4—Alarm Input 	
3.	<p>Measure two strands of twisted-pair copper wire (18-to-20 AWG) long enough to connect to the DC power source.</p>	
4.	<p>Using an 18-gauge wire-stripping tool, strip each of the two twisted pair wires coming from each DC-input power source to 0.25 inch (6.3 mm) ± 0.02 inch (0.5 mm). Do not strip more than 0.27 inch (6.8 mm) of insulation from the wire. Stripping more than the recommended amount of wire can leave exposed wire from the power connector after installation.</p>	
5.	<p>Remove the two captive screws that attach the power and alarm connector to the router, and remove the connector.</p>	

391920

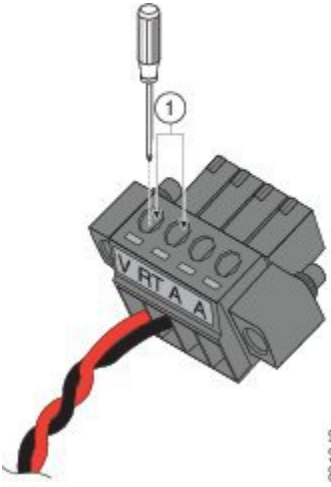
6.	<p>On the power and alarm connector, insert the exposed part of the positive wire into the connection labeled "V" and the exposed part of the return wire into the connection labeled "RT". Make sure that you cannot see any wire lead. Only wire with insulation should extend from the connector.</p> <p>NOTE: Use the same method for wiring the alarm connections.</p>	 <p>1—Power connector captive screws</p>
7.	<p>Use a ratcheting torque flathead screwdriver to torque the power connector captive screws (above the installed wire leads) to 2 in-lb (0.23 N-m).</p>	
8.	<p>Connect the other end of the positive wire to the positive terminal on the DC power source, and connect the other end of the return wire to the return terminal on the DC power source. Connect the other end of the Alarm wires to your alarm source.</p>	

Serial Port Cable

One of the more common causes for tech support calls to Cisco is improper pinouts for serial port cables. This section will describe the different components that make up the serial cabling for the IoT routers.

Note: The most common type of serial connector found is the DB9. That will be the focus for this section.

One of the popular ways to build a serial cable is through the use of a RJ-45 to DB9 adapter. These adapters can be ordered from numerous sources Online, or purchased in electronics stores. They typically come as a fixed RJ-45 female connector with loose wires, which can be inserted into a DB9 connector to match the pinouts that you need. See [Figure 44: RJ-45 to DB9 Adapter, on page 72](#).

Figure 44: RJ-45 to DB9 Adapter



Make note of the front side versus the back side of the connector. This is important when pinning the wires into the connector. In [Figure 44: RJ-45 to DB9 Adapter, on page 72](#) above, the front of the DB9 connector is present. When it is pinned, it becomes the male side of the connector.

DB9 Adapter Side

The loose side of the adapter is the DB9 side.

See [Figure 45: RS-232 DB9 Male connector Male View, on page 72](#) for an example of a typical DB9 connector with the signal names.

Figure 45: RS-232 DB9 Male connector Male View

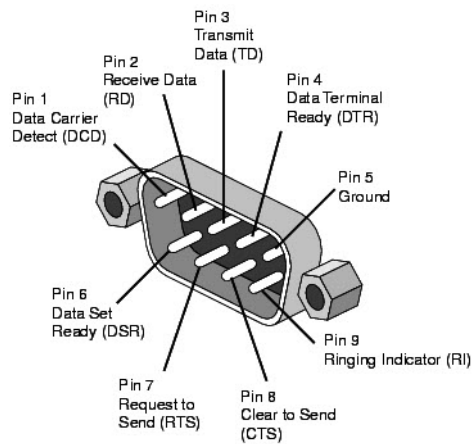

A common cause of confusion when building a connector is the perspective of how you are viewing the pinouts. The pinouts are different from the male versus female views when building the connector. See [Figure 46: DB9 Pinout Views, on page 73](#).

Figure 46: DB9 Pinout Views

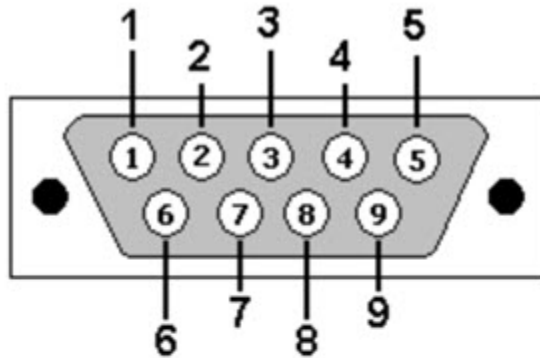

DB9: View looking into male connector

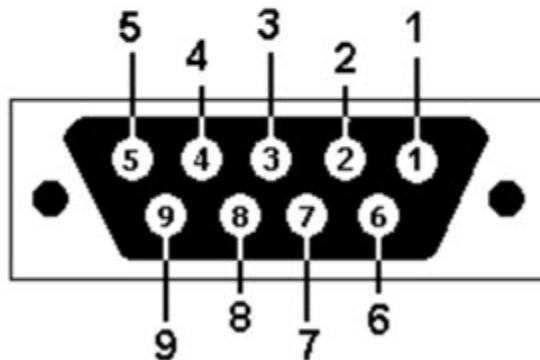

DB9: View looking into female connector

RJ-45 Adapter Side

The RJ-45 female side of the connector, as previously mentioned, has fixed wires on the connector. Refer to [Figure 47: RJ-45 Female Pinouts, on page 74](#) for the pinouts, as well as the wire colors.

Note: White can also be Gray, depending on the adapter manufacturer.

Figure 47: RJ-45 Female Pinouts

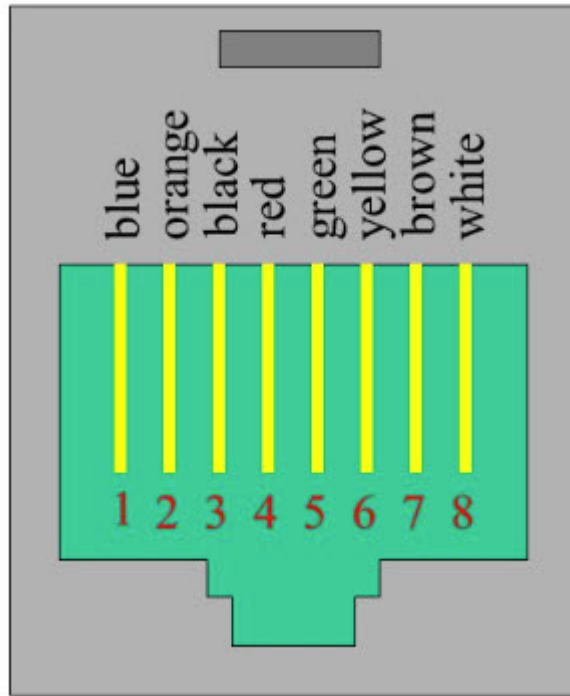

Now that both sides of the adapter have been explained, the next step is to place the pins into the proper holes of the DB9 side of the connector. This is done with the use of a pinning tool. An example of a common pinning tool is found in [Figure 48: Pinning Tool](#), on page 75.

Figure 48: Pinning Tool

There is a very good video on the use of a pinning tool that is found [here](#).

The proper pinouts for a serial port are found in [Table 21: RJ45 to DB9 Male Adapter, on page 75](#) and [Table 22: RJ45 to DB9 Female Null Modem Adapter, on page 76](#).

Table 21: RJ45 to DB9 Male Adapter

RJ-45 Pins	Wire Color	DB9 Pins
1	Blue	6
2	Orange	1
3	Black	4
4	Red	5
5	Green	2

RJ-45 Pins	Wire Color	DB9 Pins
6	Yellow	3
7	Brown	8
8	White or Gray	7

Note: [Table 21: RJ45 to DB9 Male Adapter, on page 75](#) describes the pinouts for a RJ45 to DB9 (male) Adapter. This allows connection from a local RJ45 DTE port to a far-end DCE DB9 port.

Table 22: RJ45 to DB9 Female Null Modem Adapter

RJ-45 Pins	Wire Color	DB9 Pins
1	Blue	4
2	Orange	1
3	Black	6
4	Red	5
5	Green	3
6	Yellow	2
7	Brown	7
8	White or Gray	8

Note: [Table 22: RJ45 to DB9 Female Null Modem Adapter, on page 76](#) describes the pinouts for a RJ45 to DB9 (female) Null Modem Adapter. This allows connection from a local RJ45 DTE port to a far-end DTE DB9 port.

Place the pins into their proper sockets using the pinning tool, and when that is complete you should have a connector that looks similar to the picture in [Figure 49: Completed Pinning, on page 77](#).

Figure 49: Completed Pinning

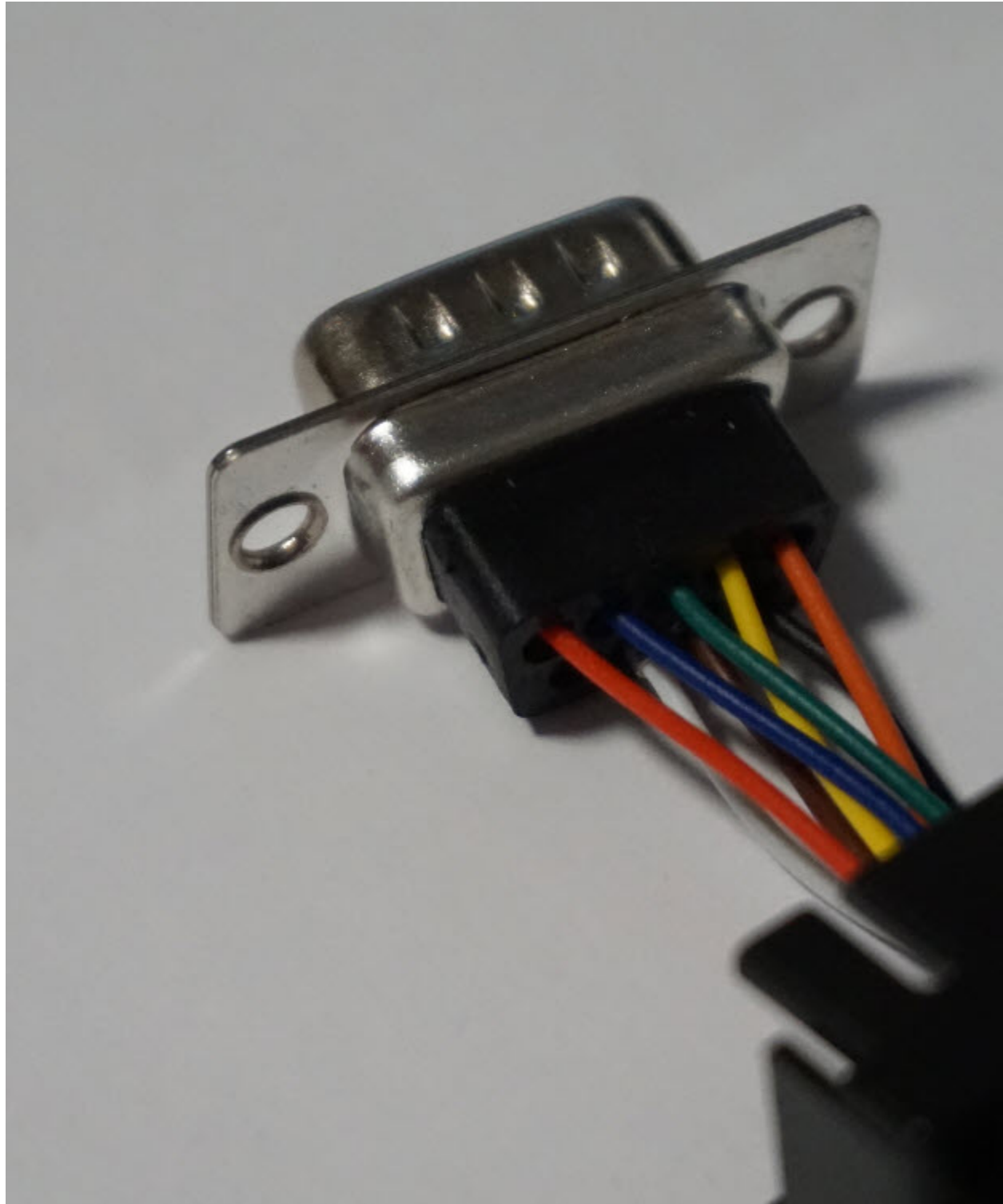

Snap the DB9 side of the adapter into place on the plastic connector holding the RJ-45 side of the connector. When this is complete, your connector is ready to use.

Verifying Connections

To verify that all devices are properly connected to the router, first turn on all the connected devices, then check the LEDs. To verify router operation, refer to the [Front Panel Icons and LEDs, on page 20](#).



CHAPTER 7

Technical Specifications

This appendix provides router, port, cabling specifications, and power adapters for the IR1101.

- [Technical Specifications, on page 79](#)

Technical Specifications

This appendix provides router and modem information for the IR1101 series.

Complete specifications for the IR1101 series can be found in the marketing data sheet.



Note Complete [Regulatory Compliance and Safety Information](#) is found online.

Router Specifications

Operating the router outside of the limits specified is not supported.

IR1101 Base Unit

The following table lists the Base Unit specifications:

Table 23: Cisco IR1101 Specifications

Description	Design Specification
Dimensions	Inches: 2.3 (H) x 5.2 (W) x 4.9 (D) Millimeters: 58.4 (H) x 132.0 (W) x 124.5 (D)
Weight	2.25 lbs.
Ingress Protection Rating	IP 30
Humidity	Non-condensing Relative Humidity: 5% to 95%

Description	Design Specification
Standard Safety Certifications	UL 60950-1, 2nd edition; CAN/CSA C22.2 No. 60950-1, 2nd edition, EN 60950-1, 2nd edition; CB to IEC 60950-1, 2nd edition with all group differences and national deviations.
Operating Temperature and Altitude on the Base IR1101 with P-LTE-xx and P-LTE-xxx Pluggables using WP7600 Series Modems. Note See Modem Specifications, on page 81 for the EM74XX Series Modems. Note Please see Modem Support for Cisco P-LTE Pluggable Product IDs (PIDs) and corresponding modem series numbers.	-40° to 140°F (-40° to 60°C) in a sealed NEMA cabinet with no airflow -40° to 158°F (-40° to 70°C) in a vented cabinet with 40 LFM of air -40° to 167°F (-40° to 75°C) in a forced air enclosure with 200 LFM of air (type tested at +85°C for 16 hours). Note This product has been safety certified up to 60°C maximum ambient.-500 to 5,000 feet. Derate max operating temperature 1.5°C per 1000 feet.
Humidity	10 – 95%
Input Voltage	Nominal voltage: 12V to 48V DC Min/Max voltage: 9.6V to 60V DC input
Typical Current	12V - 0.72A 24V - 0.36A 59.8V - 0.17A
Typical/Maximum Power Consumption	Without LTE Pluggable: Typical 7.7W, Maximum 10W. With LTE Pluggable: Typical 10W, Maximum 13W.

IRM-1100 Expansion Unit

The following table lists the Expansion Unit specifications:

Table 24: Cisco IRM-1100 Specifications

Description	Design Specification
Dimensions	Inches: 1.3 (H) x 5.2 (W) x 4.9 (D) Millimeters: 33.0 (H) x 132.0 (W) x 124.5 (D)
Weight	1.6 lbs.
Ingress Protection Rating	IP 30
Humidity	Non-condensing Relative Humidity: 5% to 95%
Standard Safety Certifications	UL 60950-1, 2nd edition; CAN/CSA C22.2 No. 60950-1, 2nd edition, EN 60950-1, 2nd edition; CB to IEC 60950-1, 2nd edition with all group differences and national deviations.

Description	Design Specification
<p>Operating Temperature and Altitude on the Expansion IRM-1100 with P-LTE-xx and P-LTE-xxx Pluggables utilizing WP7600 Series Modems.</p> <p>Note See Modem Specifications, on page 81 for the EM74XX Series Modems.</p>	<p>-40° to 140°F (-40° to 60°C) in a sealed NEMA cabinet with no airflow</p> <p>-40° to 158°F (-40° to 70°C) in a vented cabinet with 40 LFM of air</p> <p>-40° to 167°F (-40° to 75°C) in a forced air enclosure with 200 LFM of air (type tested at +85°C for 16 hours)</p> <p>Note This product has been safety certified up to 60°C maximum ambient. -500 to 5,000 feet. Derate max operating temperature 1.5°C per 1000 feet.</p>
Humidity	10 – 95%

Modem Specifications

The EM74XX series modems have different performance numbers than the WP7600 series modems do. The EM74XX series will experience reduced (throttled) performance in conditions where the ambient temperature reaches high levels. Refer to the following table for details on temperature/airflow and performance throughput.

Table 25: Specifications for the IR1101 and IRM-1100 with EM74XX Series Modems and P-LTEA-LA and P-LTEA-EA modules

Maximum Ambient Temperature (C/F)	Air Flow (LFM)	Hardware	Throughput Performance
50°/122°	0	IR1101	Normal
60°/140°	0	IR1101	Throttled
60°/140°	40	IR1101	Throttled
65°/149°	200	IR1101	Throttled
50°/122°	0	IR1101 plus IRM-1100	Normal
55°/131°	40	IR1101 plus IRM-1100	Normal
60°/141°	200	IR1101 plus IRM-1100	Normal

Table 26: Specifications for the IR1101 and LM960A18 modem, P-LTEAP18-GL pluggable module

Maximum Ambient Temp (°C/°F)	Air Flow (LFM)	Chassis Hardware	LTE Throughput Performance
50°/122°	0	IR1101	Normal
55°/131°	0	IR1101	LTE Uplink throttled
60°/140°	0	IR1101	LTE Uplink (UL) throttled, and UL RF transmit power reduced on 50% of LTE frames. Uplink communication range reduced on 50% of LTE frames.

65°/149°	0	IR1101	Same as 60C, 0 LFM and downlink (DL) C/A carrier aggregation is disabled.
70°/158°	40	IR1101	Same as 65C, 0 LFM